

Dräger Alcotest[®] 7510

de

Atemalkohol-Messgerät
Gebrauchsanweisung, Seite 2 bis 34

en

Breath Alcohol Monitor
Instructions for Use, page 36 to 68



Contents

For your Safety	38
Safety symbols used in these Instructions for Use	38
Intended use	39
What is What?	40
Scope of Delivery	40
Measuring device	41
Preparing the device for operation	42
Installing the wrist strap	42
Display, Symbols and Keys	43
Switch on and off.	44
Switch on	44
Switch off	44
Automatic shut down	44
Attaching the mouthpiece	45
Performing the measurement	46
Conditions	46
Requirements of the test subject	46
Data input before or after the measurement	47
Automatic Measurement	49
Preparation	49
Procedure	49
Test Result	50
Additional Measurement	50
Error during the delivery of the breath sample	50
Remove the mouthpiece	51
Additional Sampling Possibilities	52
Passive Sampling	52
Manual Sampling	52
Print the result protocol (basic setting)	53
Fault, Cause, Remedy	54
Maintenance	57
Maintenance intervals	57
Storage	57
Replacing the batteries	57
Charging the installed rechargeable batteries	58
Maintenance	61
Cleaning	61
Disposal of Electric and Electronic Equipment	61

Menu Functions	62
Activation	62
Operation	62
Symbols in the display	62
The Quick Menu	63
Technical Data	64
Order List.	67
Accessories, Spare Parts and Consumables	67

For your Safety

Strictly follow the instructions for use

Any use of the device requires full understanding and strict observation of these instructions. The device is to be used only for the purpose specified here.

Maintenance

The device must be inspected and serviced regularly by trained service personnel. Repairs to the device may only be carried out by trained service personnel. We recommend that a service contract be obtained with Dräger Safety and that all repairs also be carried out by Dräger Safety. Only authentic Dräger parts may be used for maintenance. Observe chapter "Maintenance intervals" on page 57.

Accessories

Use only accessories shown in the Order List, see page 67 and page 68.

Safe coupling with electrical devices

Electrical connections to devices which are not listed in these Instructions for Use should only be made following consultation with the respective manufacturers or an expert.

Not for use in explosion hazard areas

The device is not approved for use in explosion hazard areas.

Safety symbols used in these Instructions for Use

These Instructions for Use use a number of warnings for risks and hazards which might occur when using the device. These warnings contain "signal words" which will alert you to the degree of hazard you may encounter. These signal words and corresponding hazards are as follows:

 CAUTION
Bodily injuries or damage to property may occur in a situation of potential danger unless appropriate precautions have been taken. Can also be used to warn against any wanton actions.

NOTICE
Additional information for the use of the device.

Intended use

Dräger Alcotest® 7510

- Breath alcohol measuring device for the fast determination of alcoholisation of people through the measurement of the breath alcohol concentration.
- For portable, battery-powered operation.

The Alcotest 7510 can be factory-equipped with the following options:

- Operation with lithium-ion batteries
Features: high energy density, which enables a large number of measurements over the entire established temperature range.
- with GPS (Global Positioning System) for the satellite-based determination of the device location.
- with absolute pressure sensor for the compensation of atmospheric pressure during dry gas calibration.
- Mouthpiece receptacle at right or left on the "Standard" mouthpieces, with or without non return valve
or
mouthpiece receptacle at top on the "Classic" mouthpieces, with or without non return valve.



00223996_01.rtf

What is What?

Scope of Delivery

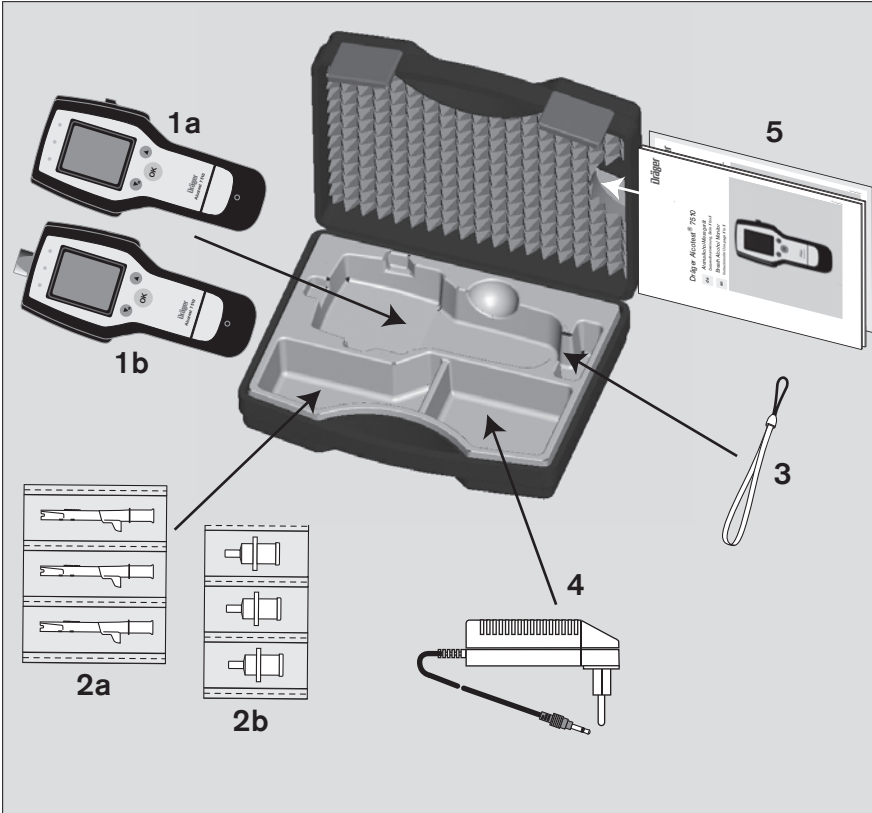

1a Measuring device: Dräger Alcotest 7510
Mouthpiece receptacle at right or left

2a "Standard" mouthpieces with non return valve, or without non return valve, 3 units

or

1b Measuring device: Dräger Alcotest 7510
Mouthpiece receptacle at top

2b "Classic" mouthpieces with non return valve, or without non return valve, 3 units

3 Wrist strap

4 Optional: Power Supply Unit 600 mA for device with NiMH or lithium-ion rechargeable batteries

5 Inserted in the case cover:

- Instructions for Use
- Quick Guide
- System CD

Measuring device

- 1 Mouthpiece receptacle available at right or left
- 2 Display
- 3 Mouthpiece ejector at right or left dependent on the mouthpiece receptacle
- 4 ▲ - key (UP)
- 5 OK - key (ON/OFF, Confirm)
- 6 Opening to the audible alarm
- 7 Charging contacts and charging connection (jack plug)
- 8 USB connection
- 9 ▼ - key (DOWN/MENU)
- 10 Infrared interface
- 11 LED red, yellow, and green

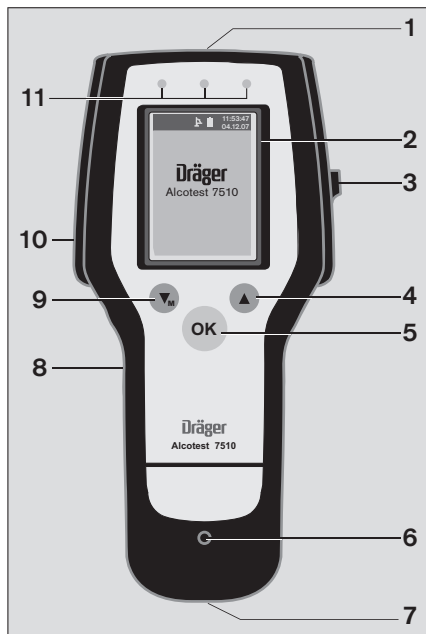

04/2399B_01.jpg

Optional:

Measuring device with

- 12 Mouthpiece receptacle at top



04/2399B_01.jpg

Preparing the device for operation

Dräger Alcotest 7510 is delivered ready for operation and factory-calibrated.

Has the calibration date expired. Display

» **Service date expired** «:

- Calibrate the device or have it calibrated by Dräger Safety or another authorised organization.
- The date of the last calibration can be viewed in the menu (see page 63).

Installing the wrist strap

- Guide the mounting strap (thin section) of the wrist strap through the housing drills on the underside of the measuring device and form a loop.
- Pull the thicker section of the wrist strap through the formed eye.

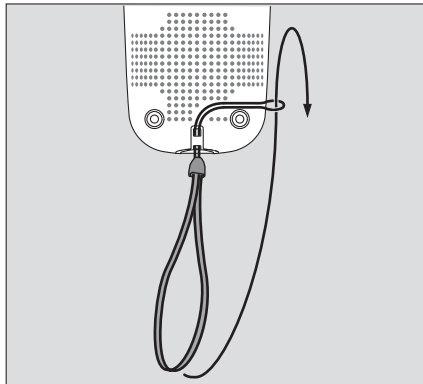

Display, Symbols and Keys

The breath alcohol measurement value is specified in units of mg/L in the basic setting of the device. The device can also be converted to all established measurement units, see Technical Handbook Dräger Alcotest 7510.

Symbols

According to the device status, the following symbols are displayed in the top row, next to the time and date information (one below the other on the right side):



There is a fault



There is a warning



The device is communicating with a PC



Database is 90 % full



Database is 100 % full, no more data can be stored



Database is 100 % full and will be overwritten with new data



GPS system active (only on devices with GPS system)



Battery or charge state of rechargeable battery: full



Battery or charge state of rechargeable battery: $\frac{2}{3}$ full



Battery or charge state of rechargeable battery: $\frac{1}{3}$ full



Battery or charge state of rechargeable battery: empty

Keys



"OK" key

- Switch on/off key for the device.
- Confirms the entry of the selected menu function(s).
- Triggers passive or manual sampling.



"DOWN / MENU"

- Sets values and selects menu functions.
- Access to the menus.



"UP"

- Sets values and selects menu functions.

Switch on and off

Switch on

- Press and hold the  key for approx. 1 second until the start screen appears.
 - A self-test is completed.
 - Device information is displayed.

If the next service date has expired:

- Have the device calibrated (see "Fault, Cause, Remedy" on page 54).

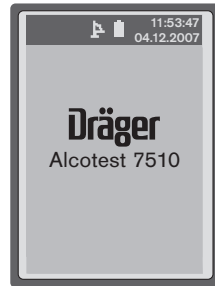

00723986_01_en.eps

Switch off

- Hold the  key pressed.
 - The device shuts down automatically after approx. 2 seconds.

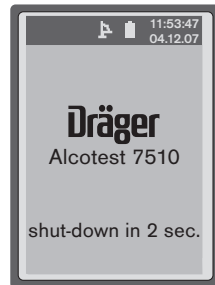

00923986_01_en.eps

Automatic shut down

In the default setting, the device shuts down automatically 4 minutes after the last operation.

The device also shuts down automatically when the batteries or rechargeable batteries are fully discharged.

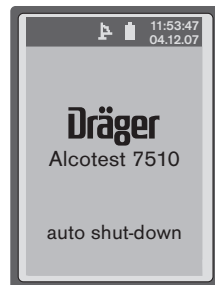

00923986_01_en.eps

Attaching the mouthpiece

- According to the version of the device, the mouthpiece can be attached with right or left orientation (Standard) or with top orientation (Classic).
- Remove the mouthpiece from the packaging. For hygienic reasons, leave the mouth contact area protected by the packaging, until the mouthpiece sits firmly on the device.

Depending on the version of the device, see page 41:

- With the chequered mark (= pressure surface) facing upwards, put the "Standard" mouthpiece into the mouthpiece receptacle at an angle and push it into the mouthpiece receptacle. The mouthpiece audibly engages.
- The inserted mouthpiece can be illuminated by the switched on device.

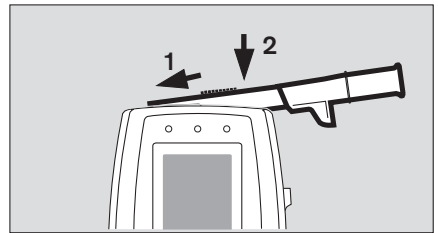

or

- From above, push the "Classic" mouthpiece firmly into the mouthpiece receptacle.
- Then completely remove the packaging.

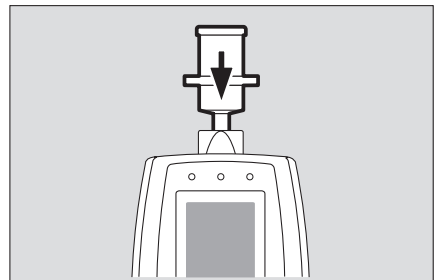

Performing the measurement

Conditions

- Insert a new mouthpiece for each test subject.
- Do not allow any high alcohol concentrations on the sensor, e.g., by rinsing the mouth with a high proof alcohol shortly before the measurement. Doing this reduces the service life of the sensor.
- Maintain an adequate distance from mobile phone antennas and transmitting stations.

Requirements of the test subject

- Observe a waiting period of at least 15 minutes after the last oral alcohol intake!
Residual alcohol in the mouth can distort the measurement. Distortions can also occur with aromatic beverages (e.g. fruit juice), alcoholic mouth sprays, medicines and drops, and after burping and vomiting. Also observe a waiting period of at least 15 minutes in these cases. A mouth rinse with water or non-alcoholic beverages does not replace the waiting period!
- The device can detect residual mouth alcohol during the delivery of the breath sample, if this option is activated. If residual mouth alcohol is detected, the measurement is aborted and a relevant message is displayed.
- The test subject should breathe normally and steadily prior to the sampling. Rapid inhalation and exhalation through the mouth should be avoided.
- The test subject must be able to produce the required minimum breath volume (default setting 1.2 L). During testing, the breath flow must fall within a preset minimum blowing period (default setting 2 seconds).

Data input before or after the measurement







Depending on the device configuration, it may be necessary to enter the data before or after the measurement.

The following examples illustrate the various data input possibilities.

- The data input can be skipped with the provided selection item "Skip" and its selection by pressing the  key.

Data input using the selection list

Example: Input of the sex of the person to be tested.



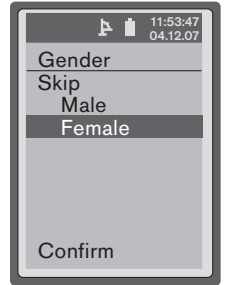





- Select the appropriate setting with the  and  key.
- Press  key.
 - The selected setting is indicated with . The cursor jumps to the bottom row "Confirm".
- Press  key, the selected setting is applied, or
- move the cursor back to the setting with the  key in order to modify it.



02823996_01_en.eps

Data input of free text with the and - keys

Example: Input of the age of the person to be tested.

- Use the  and  to enter the first digit.
- Press  key, the cursor jumps to the second position of the digit to be entered.
- Enter the second digit with the  and  key.
- Press  key, cursor jumps to the bottom row "Confirm".
- Press  key, the setting is applied, or
- move the cursor back to the setting with the  key in order to modify it.









02823996_01_en.eps

Menu-driven data input



In the menu-driven data input, numbers and letters are combined in the first level, into horizontally arranged groups.

Example: Input of the officer ID.

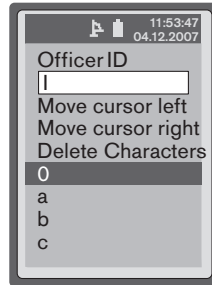
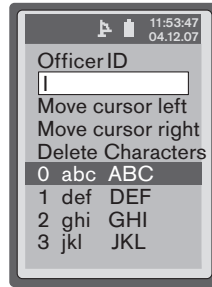

- The cursor stands at left of the empty input field.
- With the  and  key, select the group that contains the desired number or letter.
- Press  key.
- The selected group fans out in the vertical level.
- With the  and  key, select the number or letter from the group.
- Press  key.
- The first input position is set and displayed at the left of the input field next to the cursor.
- Enter additional positions in the same way.



When the input is complete:



- With the  key point the cursor on the bottom row "Confirm".
- Press  key, the setting is applied.

The position of the cursor can be changed during input:

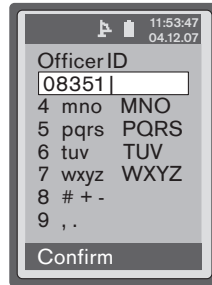
- With the  and  key position the rows "Move cursor left" or "Move cursor right".
- Press  key, the cursor position is moved one position to the left or right.



Incorrect input can be deleted:

- With the  and  key point the cursor to the row "Delete characters".
- Press  key, the character at left next to the cursor is deleted.



Automatic Measurement

The sampling is automatically triggered after attaining the minimum breath volume and the minimum blowing period.

Preparation

- Switch on the device (see page 44).
- Insert a new mouthpiece in the mouthpiece receptacle (see page 45).

After 2 seconds the following appear in the display:

- customer specific info (if activated),
or
- Input of data, see "Data input before or after the measurement" on page 47
or
- » **WAIT** «.
- The customer specific info can also be accessed by pressing the  key. End with the  key.

After a temperature-dependent heating period, the following appears in the display: » **READY** « and a short audible signal beeps. The current test number is displayed at the same time. The right LED flashes green.

The device is ready for measurement.

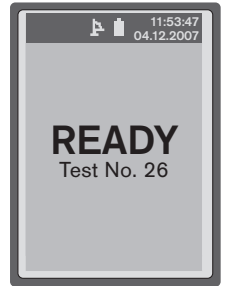

01023986_01_en.eps

Procedure

- Prompt the test person to blow evenly and continuously into the mouthpiece. A sufficient breath flow is confirmed by a continuous audible signal and the green LED.

During the delivery of the breath sample the following message appears in the display: » **BLOW** «.

If the breath sample is sufficient (minimum breath volume and the minimum blowing period were reached), the sampling is triggered. Then the green LED goes out, the audible signal stops.

The following message appears in the display:

» **WAIT Analyzing** «



01023986_01_en.eps

Test Result

After 3 to 20 seconds (dependent on the detected concentration) the measurement result appears in the display.

- The measurement result is displayed with the corresponding unit.
- In the default setting, the unit is set to mg/L (milligram ethyl alcohol per liter breathing air) and the solution is set to two positions after the comma. The default setting can be changed on the main menu (see Technical Handbook Dräger Alcotest 7510).

In addition to the measurement result, an audible signal which is dependent on the measurement result is output, for example: measurement result below the limit value (PASS) = 1 x, measurement result between the limit values (ALERT) = 2 x, measurement result above the limit value (FAIL) = 3 x

If the measurement results are positive, it is recommended to perform a second measurement after 10 to 15 minutes in order to confirm the measurement result.

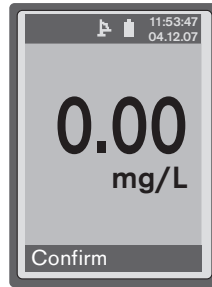

Documentation of the Results:

- A result protocol can be generated with the Dräger Mobile Printer, see page 53.

Additional Measurement

- Pressing the **OK** key prepares a new measurement. During the recovery time of the sensor (see "Technical Data" on page 65) the following appears in the display: » **WAIT** «

NOTICE
Periodically switching off the device does not reduce this waiting period!

Error during the delivery of the breath sample

If the volume of the breath sample is insufficient, the following appears in the display:

» **Insufficient volume** «.

A short audible signal beeps and the red LED flashes.

To repeat, press the **OK** key.

Waiting period for a new testing standby is 4 to 20 seconds.

In the case of highly irregular exhalation, e.g. sudden termination or suction at the end of the breath sample, the following appears in the display: » **Blow interruption** «.

A short audible signal beeps and the red LED flashes.

To repeat, press the **OK** key.

Waiting period for a new testing standby is 4 to 20 seconds.



Remove the mouthpiece

Depending on the version of the device, see page 41:

- Push the eject button upwards. The mouthpiece is pushed out of the mouthpiece receptacle.

or

- Remove the mouthpiece upwards out of the mouthpiece receptacle.

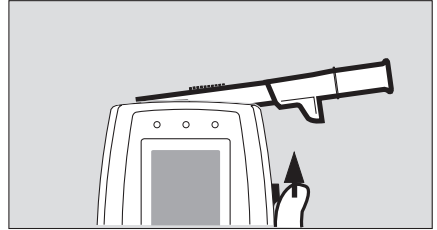

01E23996_01.eps

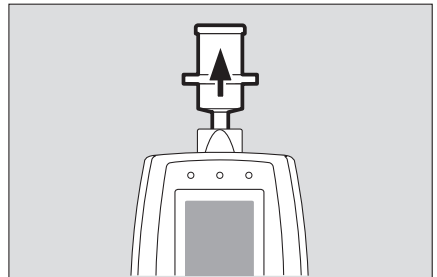

02723996_01.eps

⚠ CAUTION

For hygienic reasons, do not directly touch the mouth contact area of the used mouthpiece. Risk of infection!

Dispose of used mouthpieces in accordance with the local regulations.

Additional Sampling Possibilities

In the menu, the functions can also be switched on or off in combination (see Technical Handbook Dräger Alcotest 7510).

Passive Sampling

With passive sampling, the sampling is manually triggered by the user of the device. Possible applications include the testing of the ambient air or the testing of the exhaled air of non-cooperating (e.g. unconscious) persons for the presence of alcohol.

- Hold the ready to measure **device without mouthpiece** in the air to be analysed.
- Briefly press  key.

Display » **NO ALCOHOL** «:
if no alcohol is present in the air to be analyzed.

or:

Display » **ALCOHOL** «:
if alcohol is present in the air to be analyzed.

Documentation of the Results:

A result protocol can be generated with the Dräger Mobile Printer, see page 53.

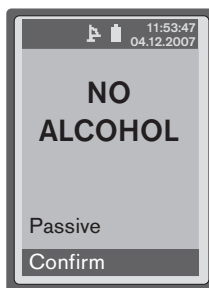

Manual Sampling

The sampling can also be manually triggered if the test subject cannot produce the required breath volume.

Preparation and procedure as per automatic measurement (see page 49).

- If » **BLOW** « appears in the display after the start of the exhalation and the test subject is no longer able to continue with the breath sample, briefly press the  key. The sampling is now triggered.

During the result display, the message » **Manual** « also appears in the display.

Documentation of the Results:

A result protocol can be generated with the Dräger Mobile Printer, see page 53.

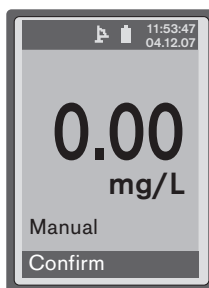

Print the result protocol (basic setting)

With the Dräger Mobile Printer, see page 68.

Preparation:

- Switch on the Dräger Mobile Printer.

If the Dräger Alcotest 7510 displays the test result:

- Place the device next to the Dräger Mobile Printer in such a way that the infrared interfaces (IR) directly face each other.
 - The printing of the protocol automatically begins.

If the printing is done:

- Press  key to start a new measurement.

Printing stored test results:

- see Technical Handbook, function » **Show last tests** «.

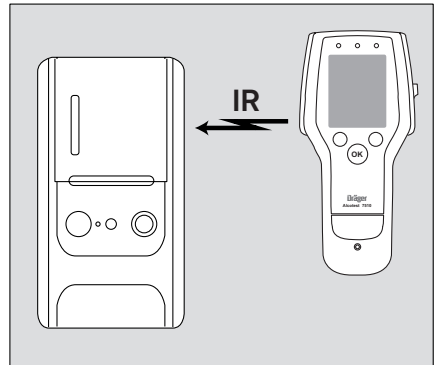

03P23956C_01.jpg

Fault, Cause, Remedy

An error message appears if a device fault occurs (see table).

The number that appears below the message is used for service functions. If the fault remains after repeatedly switching the device on and off, contact Dräger Safety.

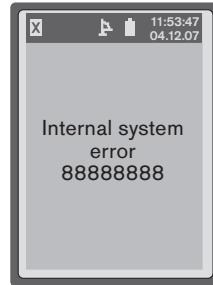

Fault	Cause	Remedy
Device automatically switches off	Discharge the rechargeable battery / batteries	Replace batteries, page 57 or charge the rechargeable batteries, page 58.
	Device was ready to measure longer than 4 minutes	Switch on device again.
Battery symbol empty	Discharge the rechargeable battery / batteries	At the next opportunity, replace batteries, page 57 or charge the rechargeable batteries, page 58.
Date / time incorrect	Discharge backup battery	Set date / time, page 63. Work with charged batteries.
Menu is automatically exited	The device automatically returns to the measurement function after 120 seconds	Select the menu item again.
Not possible to switch on the device	Discharge the rechargeable battery / batteries	Replace batteries, page 57 or charge the rechargeable batteries, page 58.
Insufficient volume / invalid sample	Test subject blows too weakly or non-continuously	Blow more strongly and continuously.
No continuous tone during blowing	Device is not yet ready to measure	Wait until the device is ready to measure.

Error message in the display	Cause	Remedy
» Mouth alcohol «	Residual alcohol in oral cavity not completely reabsorbed.	Repeat the measurement again approx. 15 minutes after the last alcohol intake.
↑ ↑ ↑	Measured value exceeds display area.	Use lower concentrations.
» No printout possible «	Dräger Mobile Printer not recognised or protocol not completely processed.	Maintain a visual connection and close proximity between the IR interfaces of the devices during the entire printing period.
» Temperature out of range «	Device temperature is outside of the allowed temperature range.	Heat or cool the device and start the measurement again.
» Service date expired « The device alerts and blocks the operation, if set	The service interval is expired.	Calibrate device; by trained service personnel, e.g. from Dräger Safety.
» Calibration error «	Calibration not successful.	Calibrate device again; by trained service personnel, e.g. from Dräger Safety.
» Accuracy check failed «	Calibration test not successful.	Calibrate device; by trained service personnel, e.g. from Dräger Safety.
» Sensor failure «	Sensor not within the specification.	Switch the device off and on again. If the error message appears again: have the sensor replaced by trained service personnel, e.g. from Dräger Safety.
» Error datalogger «	Data storage not possible.	Read the data memory and re-initialise; by trained service personnel, e.g. from Dräger Safety.
» RFI error «	Electromagnetic fault is too strong.	Correct fault source and repeat measurement.
» GPS – position not found «	No free visibility to the satellites.	Move to a location with free visibility and hold the device with the display directed upwards.

Error message in the display	Cause	Remedy
<p>» Internal System error « with fault number and text</p> <p>Examples:</p>	Device fault.	Remove batteries for a short period of time (2 seconds) and reinsert (only possible with alkaline batteries or NiMH rechargeable batteries). If the error continues to occur: make a claim with Dräger Safety Service.
. . . heating system	Device is not ready to measure	Call Dräger Safety Service.
. . . EC-sensor (offset)	Device is not ready to measure	Call Dräger Safety Service.
. . . sampling system	Frequency determination not successful.	Call Dräger Safety Service.
	Pressure values not OK.	
. . . backup battery	RTC Error	Call Dräger Safety Service.
. . . GPS communication	Module Error	Call Dräger Safety Service.
» No Charging Temperature out of range «	Charger is connected, but the device temperature is outside of the allowed charging temperature range.	Heat or cool the device. Start the charging process again.
» Wrong batteries «	Only with alkaline batteries or NiMH rechargeable batteries: cells incorrectly inserted (polarity swapped).	Check the orientation (polarity) of the alkaline batteries or NiMH rechargeable batteries and insert correctly if necessary.
	Only with alkaline batteries or NiMH rechargeable batteries: individual cells defective.	Check the alkaline batteries or NiMH rechargeable batteries and replace if necessary.

Maintenance

Maintenance intervals

As required:

- Replace batteries, see page 57 or charge rechargeable batteries, see page 58.

Every six months:

- Check calibration. Only by authorised persons, see Technical Handbook Dräger Alcotest 7510.
- An extension of the calibration interval, e.g. to 1 year, is possible.
Prerequisite: Analysis of the sensor data and other quality assurance measures by the Service department of Dräger Safety.

Storage

- The Dräger Alcotest 7510 also uses some power when it is in a deactivated state. Therefore, remove the batteries or rechargeable batteries from the device when not in use for a longer period of time.

CAUTION

During long storage periods: remove the batteries or rechargeable NiMH batteries from the device when the device is not used for longer than 6 months. This avoids damage to the device caused by leaking battery acid.

Replacing the batteries

For devices with alkaline batteries or NiMH rechargeable batteries.
Lithium-ion rechargeable batteries cannot be replaced.

If the battery symbol in the display stands at »  « (empty) insert new batteries or charged NiMH rechargeable batteries, or place the device in the charger and charge:

- Rotate the catch on the battery cover anticlockwise 90° and remove the battery cover.
- On devices with NiMH rechargeable batteries, the catch is secured on the battery cover with a screw.

If the NiMH rechargeable batteries need to be replaced:

- In order to open the battery cover, first loosen the screw. Then rotate the catch 90° and remove the battery cover.

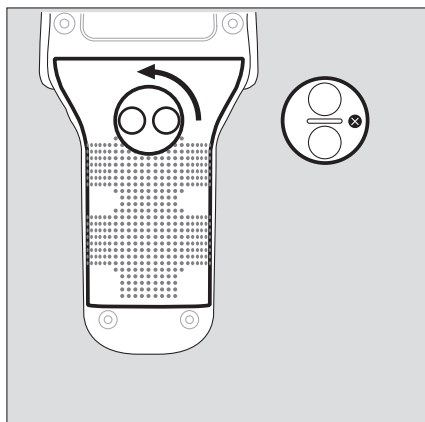

- Remove used alkaline batteries or NiMH rechargeable batteries and insert new alkaline batteries or charged NiMH re-chargeable batteries – observe correct polarity!
- Replace the battery cover and lock the catch with a clockwise rotation. On devices with NiMH rechargeable batteries, secure the catch on the battery cover with the screw.

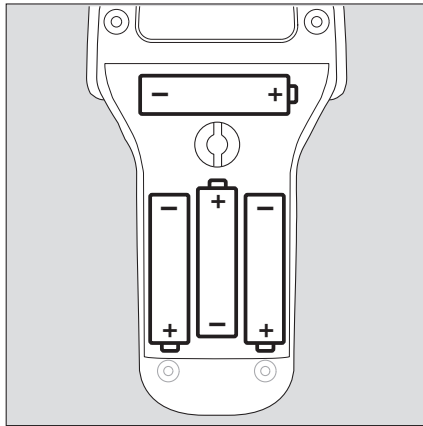

02023896_01.eps

Required batteries::

4 units 1.5 V alkaline type (Mignon, LR6, AA)

or

4 units 1.2 V NiMH rechargeable batteries

- In order to immediately reinsert the device after discharging the alkaline batteries or the NiMH rechargeable batteries, it is recommended to have replacement batteries or charged rechargeable batteries on hand.

CAUTION

Do not throw used alkaline batteries or NiMH rechargeable batteries into fire, charge them again, or open them by force. Danger of explosion!



Dispose of used alkaline batteries or NiMH rechargeable batteries only as hazardous waste, in accordance with local waste disposal regulations.

Further information can be obtained from the relevant local authority and from appropriate waste disposal companies.

Charging the installed rechargeable batteries

For devices with NiMH or lithium-ion rechargeable batteries.

If the battery symbol in the display stands at »  « (empty) or if the device automatically switches off before reaching operational readiness:

- Charge the rechargeable batteries in the device or replace the NiMH rechargeable batteries with charged rechargeable batteries, see page 57.

Only charge the device at temperatures between 5 and 40 °C (avoid exposure to direct sunlight). At extremely high or low temperatures, the device automatically stops the charging process.

Charging on the mains

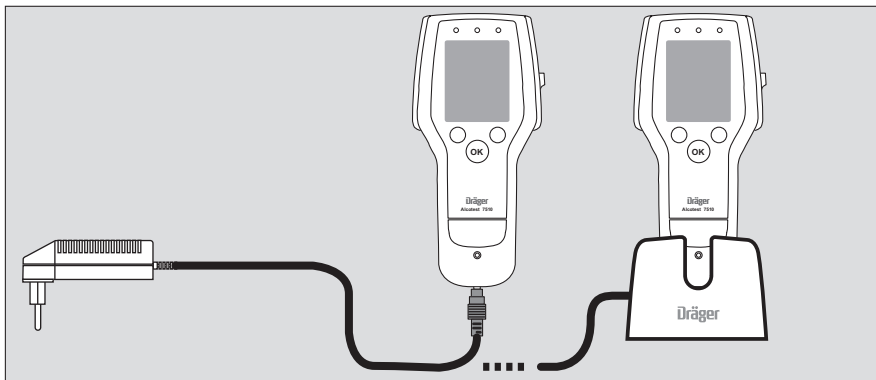

For charging on the mains, the power supply unit 600 mA (Part No. 83 16 991) and, optionally, the desktop charging cradle, is required.

- Connect the power supply unit 600 mA to the mains (100 to 240 V AC).
- Insert the jack plug into the charging socket of the device.
- or
- Insert the jack plug into the charging socket on the rear side of the charging cradle and place the device in the charging cradle with the front side facing forwards. Allow the carrying strap to dangle out of the front of the device, so that it does not block the contacts.

Car Charging

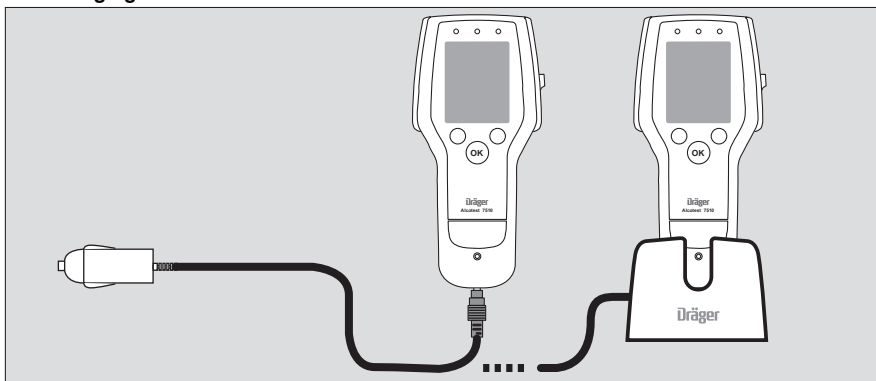

For charging in the car, the car charger 600 mA (Part No. 83 20 252) and, optionally, the desktop charging module, is required.

- Insert the connector of the car charger into the cigarette lighter receptacle.
- Insert the jack plug into the charging socket of the device.
- or
- Insert the jack plug into the charging socket on the rear side of the charging cradle and place the device in the charging cradle with the front side facing forwards. Allow the carrying strap to dangle out of the front of the device, so that it does not block the contacts.

During the entire charging process on the mains or in the car:

- The following message appears in the display: » **Charging** «
The battery symbol also cyclically switches the charge state from empty to full.
- A discharged rechargeable battery is completely recharged in approx. 6 to 8 hours.
- The message » **Charging complete** « appears in the display.



03523996_01_en.eps

⚠ CAUTION

The charging accessories listed in the order list, page 67, are to be used only.

NOTICE

Obtain the charge state of the rechargeable batteries.

For NiMH rechargeable batteries:

To ensure the operational readiness of the device even when it is not in use, completely charge the rechargeable battery at least every 3 months.

For lithium-ion rechargeable batteries:

When not in use for a longer period of time, charge to at least 50 % every 6 months in order to prevent a reduction in the service life (see function » 50% charging « in the quick menu on page 63).

Maintenance

The device does not need any special maintenance.

- If dirt and deposits are present, the charging contacts must be carefully cleaned.

Cleaning

- Do not submerge in liquids, no liquids can touch the connectors!

For cleaning:

- wipe with a disposable towel.
- do not use any detergents that contain alcohol or solvents.

 CAUTION
--

The use of detergents with a high alcohol content can greatly reduce the service life of the internal sensor or generate an erroneous positive test result in the short-term.

Disposal of Electric and Electronic Equipment



EU-wide regulations for the disposal of electric and electronic appliances, which have been defined in the EU Directive 2002/96/EC and in national laws, are effective from August 2005 and apply to this device.

Common household appliances can be disposed of using special collecting and recycling facilities. However, as this device has not been registered for household usage, it must not be disposed of through these means. The device can be returned to your national Dräger Safety Sales Organization for disposal. Please do not hesitate to contact the above if you have any further questions on this issue.





Menu Functions

Activation

Switch on the device. After the message » **WAIT** « or » **READY** « appears, the menu functions can be selected.

- For the "**Quick Menu** ": briefly press the  key.
- The "**Main Menu** " is only accessible to authorised persons with PIN entry, see Technical Handbook Dräger Alcotest 7510.







Operation

- Select functions with the  key and the  key:
- The selected function is displayed inverted.
- Activation of the selected function with the  key.
- Selecting " **Back to measurement**" brings the device back into the measurement mode by pressing the  key.

If no key is pressed within 120 seconds, the device automatically returns to the measurement mode.

Symbols in the display

Graphical symbols (icons) simplify the navigation through the various menus:

-  Return to next menu level
-  Menu item with submenu
-  Open menu item
-  Selected function
-  Other entries below visible entries
-  Other entries above visible entries

Function

- ✓ Activated function or setting.
- 1/6 Current display (1) of the total display number (6)

The Quick Menu

The following functions are active in the default setting on device delivery.

■ » Show last tests «

Select the last tests with the \downarrow , and \uparrow keys.

Go back with the OK key.

The data records of the last tests can be transferred to a PC with the PC program Dräger Diagnostics.

■ » Show cal. dates «

Show last and next calibration date.

Go back with the OK key.

■ » Set contrast/backlight «

Setting of contrast and backlight of the display background light.

Modify with the \downarrow , and \uparrow keys.

Go back with the OK key.

■ » Show last error «

The last occurred error is displayed.

Go back with the OK key.

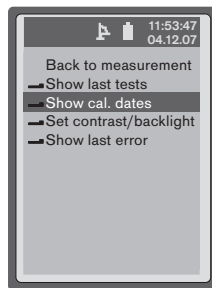

03223996_01_en.npa

The size of the quick menu can be expanded with the PC software Dräger Diagnostics, e.g.:

■ » Set date «

Set with the \downarrow , and \uparrow keys.

Go back with the OK key.

■ » Set time «

Set with the \downarrow , and \uparrow keys.

Go back with the OK key.

■ » Set language «

Select with the \downarrow , and \uparrow keys..

Go back with the OK key.

■ » Accuracy check «

After selecting the accuracy check with the OK , the test gas that must be used appears in the display.

Continue the procedure according to the messages in display.

After supplying gas to the instrument the result will be displayed, if applicable the device functions will be locked/unlocked dependent on deviation to target value.

■ » 50% charging «

Complete 50% charging of lithium ion batteries for periods of longer storage.

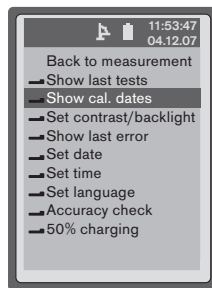

03223996_01_en.npa

Technical Data

Measuring Principle

Electrochemical sensor

Measuring range (Default setting)

Breath alcohol concentration	0.00 to 3.0 mg/L (Ethyl alcohol mass per breath volume at 34 °C and 1013 hPa.)
Blood alcohol concentration	0,00 bis 6,00 ‰ (Ethyl alcohol mass per blood volume or blood mass at 20 °C and 1013 hPa. By giving this data, a conversion factor of 2100 is used between the breath alcohol concentration and blood alcohol concentration.)

Display Area

The display is identical with the measuring range.

If the measurement result is outside of the measuring range, three arrows are shown in the display » ↑ ↑ ↑ « = Measuring range exceeded.

Ambient conditions

during operation	-10 to 50 °C 10 to 100 % r.H. (non-condensing) 600 to 1100 hPa
during storage	-40 to 70 °C

Sampling

minimum blowing time	adjustable preset at 2 seconds
minimum volume	adjustable preset at 1.2 liter

Analysis Time

Time from the end of sample delivery to the displaying of the results. The analysis time is dependent on the ambient temperature.

at room temperature:

0.00 mg/L	<4 seconds
0.50 mg/L	<10 seconds

at 0 °C:

0.00 mg/L	<4 seconds
0.50 mg/L	<20 seconds

Measuring accuracy

Standard deviation of the repeatability with ethyl alcohol standard in the temperature range -5 bis 40 °C)

to 0.50 mg/L	0.008 mg/L or
≥0,50 mg/L	1.7 % of measured value whichever value is greater
to 1.00 ‰	0.017 ‰ or
≥1.00 ‰	1.7 % of measured value whichever value is greater

Sensitivity drift typically 0.6 % of the measurement value/month

Waiting period between measurements

The sensor is heated in relation to the outside temperature. This means that the waiting periods are significantly reduced in comparison with unheated systems.

Waiting period after a previous measurement with:
(specification in breath alcohol concentration)

0.00 mg/L	<10 seconds
>0.00 mg/L, independent of the concentration	<20 seconds

Values for other units of measurements can be calculated and displayed accordingly.

Dimensions (H x W x D)

with alkaline batteries or NiMH rechargeable batteries approx. 185 mm x 90 mm x 44 mm
with lithium-ion rechargeable batteries approx. 185 mm x 90 mm x 49 mm

Weight

approx. 433 g (with batteries / rechargeable batteries)

Power supply

Alkaline batteries 4 units 1.5 V alkaline type (Mignon, LR6, AA)
approx. 1500 measurements, or
NiMH rechargeable batteries 4 units 1.2 V NiMH (Mignon, LR6, AA)
approx. 1500 measurements, or
lithium-ion rechargeable battery integrated in the device
approx. 50 % more measurements possible than
with NiMH rechargeable batteries

CE marking

Electromagnetic compatibility
(Directive 89/336/EEC)

Order List

Name and Description	Part No.
Dräger Alcotest 7510 Standard	83 19 760
Dräger Alcotest 7510 Customer specific configuration	83 19 700
Accessories, Spare Parts and Consumables	
"Standard" mouthpiece without non return valve (1000 units)	68 10 830
"Standard" mouthpiece with non return valve (1000 units)	68 11 065
"Classic" mouthpiece without non return valve (25 units)	68 05 700
"Classic" mouthpiece with non return valve (25 units)	68 05 703
Alkaline battery (1 unit)	13 35 804
NiMH rechargeable battery (1 unit)	18 90 092
Power Supply Unit 600 mA for charging devices with NiMH rechargeable batteries or with a lithium-ion rechargeable battery	83 16 991
Car charger 600 mA	83 20 252
Desktop charging cradle, compl. Alcotest 7510 to charge the Dräger Alcotest 7510 with power supply 83 16 991. Consisting of: charging cradle base unit, charging cradle adapter, wall bracket	83 19 762
Holster Set, compl. Alcotest 7510 consisting of: holster, belt clip, protective cover plus div. velcro fasten- ing (e.g. to attach inside vehicles)	83 19 761

Name and Description	Part No.
IR-Modul Alcotest 7510 Infrared interface adapter for Holster Alcotest 7510 for data transfer via IR interface. The adapter can be connected via an USB cable to a PC.	83 19 763
IR-Module + Holster Alcotest 7510 consisting of: Holster and IR-Modul Alcotest 7510 (83 19 763). Use in conjunction with 83 19 765 for mobile use. Use in conjunction with 83 19 762 for stationary use.	83 19 764
Holster Set Alcotest 7510 consisting of... belt clip, protective cover plus div. velcro fastening as add-on of 83 19 764 resp. also spare part of 83 19 761	83 19 765
Device case for the Dräger Alcotest 7510 and Dräger Mobile Printer. Space for mouthpieces, batteries, paper rolls, charging cable, communication cable, keyboard, etc.	83 20 251
Dräger Mobile Printer	83 19 310
Dräger Diagnostics PC program for the data communication with Dräger Alcotest 7510	83 19 342
USB cable ¹⁾	83 18 657
Wrist strap	83 17 922
Packaging unit for Dräger Alcotest 7510	83 19 747
Quick Guide Dräger Alcotest 7510	90 33 040
Technical Handbook Dräger Alcotest 7510	90 23 997

1) When using a different USB cable, observe a maximum length of 3 m for CE reasons.



 **Order here!**

Dräger Safety AG & Co. KGaA

Revalstraße 1

D-23560 Lübeck

Germany

Tel. +49 451 8 82- 0

Fax +49 451 8 82- 20 80

www.draeger.com

90 23 996 - GA 4754.600 de_en

© Dräger Safety AG & Co. KGaA

3rd edition - 09_2008

Subject to alteration