



# Pharmacy/Medical Refrigerator Operation Manual

The following product models are applicable:

YC-55L	YC-55EL
YC-56L	YC-56EL
YC-75L	YC-75EL
YC-76L	YC-76EL
YC-130L	YC-130EL
YC-315L	YC-315EL
YC-330L	YC-330EL
YC-395L	YC-395EL
YC-400L	YC-400EL
YC-525L	YC-525EL
YC-725L	YC-725EL
YC-1015L	YC-1015EL
YC-1320L	YC-650L
YC-1505L	

Zhongke Meiling Cryogenics Company Limited





Better science, Better life!

[www.melingbiomedical.com](http://www.melingbiomedical.com)

[zkmeiling@zkmeiling.com](mailto:zkmeiling@zkmeiling.com)























# Table of Contents

<b>1. Application Notes</b> .....	1
<b>2. Safety Instructions</b> .....	2
<b>3. Precautions in Use</b> .....	4
<b>4. Installation and Commissioning</b> .....	4
4.1 Installation Environment .....	4
4.2 Installation Site .....	4
4.3 Preparation before Use .....	5
4.4 First Power-on .....	5
4.5 Operation after Power Failure .....	6
<b>5. Product Composition and Overview</b> .....	7
<b>6. Operating Instructions</b> .....	10
6.1 Function Introduction .....	10
6.2 Optional Function .....	18
<b>7. Maintenance and Service</b> .....	19
7.1 Equipment Maintenance .....	19
7.2 Equipment Discontinuation .....	19
7.3 Maintenance, Replacement, and Recovery of Rechargeable Batteries .....	19
<b>8. Troubleshooting and Maintenance Services</b> .....	20
<b>9. Specifications</b> .....	21
<b>10. Packing List</b> .....	26





	Do not place the equipment in areas exposed to the sun or rain, so as to prevent danger such as short circuit or overheating.
	Do not tilt or lay the equipment sideways, and do not impact the equipment body; Refrigeration systems are installed in the equipment, which is easy to be damaged by tilt or impact.
	Please place the equipment in a dry and dust-free environment to avoid risks such as overheating, and short circuit.
	In case of unexpected sound, smell, smoke, etc. when the power is turned on, please unplug the power in time and contact the manufacturer or supplier.
	Please place the equipment in a dry and ventilated environment, and ensure that the equipment vents and instrument surfaces are not blocked or shielded by walls or other objects; Do not use it in a poorly ventilated environment to prevent damage caused by heat released by equipment.
	It is forbidden to disassemble and modify this equipment without authorization, so as to avoid potential safety hazards. In this case, MELING BIOMEDICAL will not bear any responsibility for quality accidents.
	It is forbidden to put inflammable and explosive dangerous goods, strong corrosive acids, alkalis and other items unsuitable for the equipment in the equipment.
	When storing toxic, harmful or radioactive materials, please use the equipment in safe areas. Improper use may cause harm to human health or environment.
	Metal objects such as nails or iron wires shall not be inserted into any aperture and gap or any outlet of the equipment, otherwise electric shock or injury may be caused due to accidental contact between the above objects and moving parts.
	In order to ensure the normal operation and ventilation and heat dissipation of the equipment, the back, left and right sides of the cabinet shall be at least 30cm away from the wall, and the air inlet and air outlet must not be blocked by obstacles.
	This equipment must be connected to a ground wire.

	<b>Note:</b> Failure to observe the precautions may result in personal injury or equipment failure and related property losses.
	It is forbidden to store living animals, flowers or other items with strict temperature requirements in the equipment.
	When the equipment is running, do not touch the inner surface of the cabinet without wearing protective gear.
	Hold the handle and close the door to avoid pinching your fingers; When the equipment is not used for a long time, please unplug it and pack it for storage.
	When restarting the equipment after power failure or power off, please check the equipment settings first, otherwise the stored items may be damaged due to the change of settings.
	The equipment can be used for item preservation, not as production equipment.
	Keep the keys properly, so as to avoid accidents when children open the door accidentally.
	When handling the equipment, please be careful not to tip over the equipment, so as to prevent equipment damage or personal injury.
	When handling, it shall be lifted from the bottom, with the inclined plane not be greater than 45°, and it shall be handled with care. Please use the equipment in safe areas. Improper use may cause harm to human health or environment.





### 4.3 Preparation before use

1. Remove the outer packaging of all products (including the protective foam in the packaging box).  
 **Warning:** Don't put the plastic bags within the reach of children, so as to prevent suffocation accidents.

2. Inventory of accessories: Please check the accessories and materials according to the packing list.
3. Cleaning: Clean the product once before use.
4. Before use, remove the small wire shelf and put it at the bottom of the cabinet (applicable to YC-55L/YC-55EL /YC-56L/YC-56ELand YC-75L/YC-75EL/YC-76L/YC-76EL).
5. Installation of door handles (YC-650L, YC-725L, YC-725EL, YC-1015L, YC-1015EL, YC-1320L, YC-1505L).

In order to install handles, the handles shall be placed together with accessories.

#### Handle installation method:

Firstly, open the door handle as shown in the following figure;

Then, remove the screw for installing the door handle on the cabinet, and install the handle seat with this screw;  
 Finally, install the handle cover, insert both ends of the handle cover into the corresponding grooves of the handle seat, and then press it to close it.

6. Install the fixing plates (Apply to YC-725L, YC-725EL (110V 60Hz)).
  - a. Firstly take out the two fixing plates and check if consistent.
  - b. Remove the bolts from the fixing plate, and then fix the plate on the back of the refrigerator.
  - c. Connect the fixing plate to the immovable wall or bracket on the back of the refrigerator and finally check whether it is fixed.

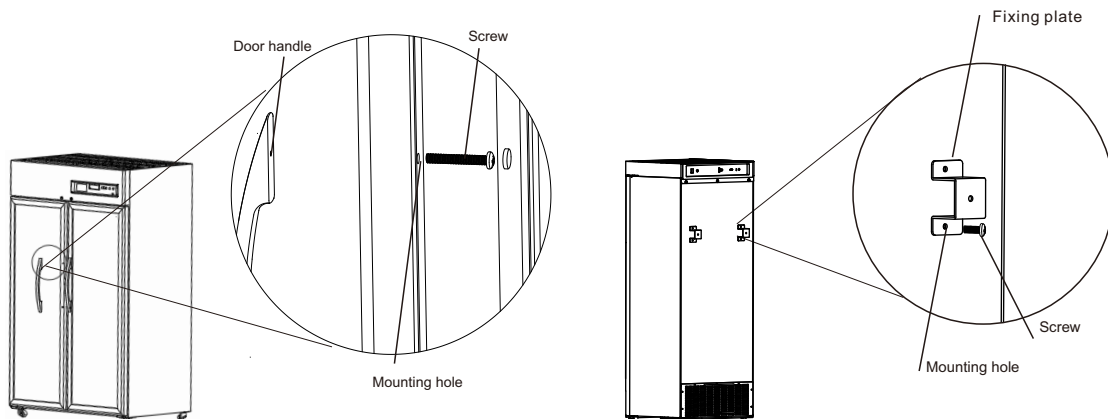

### 4.4 First Power-on

When using the equipment for the first time, please follow these steps:

1. After the equipment is placed, leveled and cleaned, it shall stand for more than 24 hours, and then power it on to ensure the normal operation of the equipment.
2. Under no-load condition, connect the power cord to a special outlet with appropriate specifications.
3. After powering on, turn on the power switch of the equipment. Toggle the on/off battery switch to the ON position located in the back of the unit.
4. Check whether the operating temperature of the equipment reaches the required value, observe the normal start and stop of the equipment for more than 24 hours, and put a small amount of items in the Refrigerator after confirming the normal performance.
5. Please store items in batches, with the items not exceeding 1/3 of the cabinet volume each time. Ensure that the equipment is running properly after shutdown for more than 12 hours before putting in the next batch of items).
6. Try not to open the door during cooling, otherwise the temperature will rise.

---

## 4.5 Operation after Power Failure

1. The equipment has a memory function for the set value. When the power is restored after power failure, the equipment will continue to operate before power failure.
2. Once the equipment is powered off, it requires 5 minutes before it can be switched on again, so as to avoid damaging the compressor.
3. We guarantee the normal operation of this equipment under certain conditions, but we are not responsible for any loss or damage of stored items after power failure.



### Notes:

- ◆ A special person shall be responsible for checking and recording the running status of the equipment every day (record and check once every 2-4 hours). In case of failure or shutdown, the temperature in the Refrigerator will rise. If it cannot be repaired in a short time, please take out the stored items and transfer them to a place that meets the temperature requirements for storage to avoid damage to the items.
- ◆ Before putting items into the equipment, it shall be confirmed in advance whether the temperature range of the equipment meets the temperature requirement of the items, so as to avoid damage to stored items due to the difference between the settable temperature of the equipment and the required temperature of the items. Please pay attention not to block the air outlet and air inlet when putting items into the equipment.
- ◆ Due to the refrigeration inertia, there is a certain difference between the actual display temperature and the set temperature of the equipment, which is a normal phenomenon.
- ◆ The equipment is an item storage equipment, which cannot be used for routine production operations. It is strictly forbidden to put too many items which are relatively hot into the equipment at one time, otherwise the compressor will run for a long time, and be burned due to high temperature. Items must be put in batches, so as to ensure that the Refrigerator is cooled step by step until the temperature required for storing items is reached.
- ◆ Electrical appliances without production license shall not be used inside the equipment.
- ◆ Do not change the set temperature frequently in a short time, otherwise the expected setting effect may not be achieved due to the large temperature inertia; Ensure that there is a certain air circulation space around the cabinet when putting in items, especially do not block the temperature sensor in the cabinet (for collecting the temperature of the cabinet), otherwise it will affect the stability and accurate control of the temperature in the cabinet!
- ◆ Items shall not be placed directly at the bottom of the Refrigerator, but on the bottom shelf, otherwise the refrigeration effect of the equipment will be affected.
- ◆ When putting in items, if the moisture content of the items is too much or too little, it will affect the humidity change in the cabinet, so it is best to keep the items sealed; The humidity of the working environment will affect the change of humidity in the cabinet, especially if the door is opened too frequently and the door is not closed properly.



### Warning:

- ◆ Children are not allowed to play with this equipment as a game prop, otherwise the injury or loss caused therefrom will be at their own risk.
- ◆ To avoid the risk of electric shock, this equipment must only be connected to a supply mains with protective earth.
- ◆ No modification of this equipment is allowed.
- ◆ Do not modify this equipment without authorization of the manufacturer.
- ◆ Protection impairment if used in a manner not specified by the manufacturer.
- ◆ The instructions concerning persons (including children) with reduced physical, sensory or mental capabilities, or lack of experience and knowledge and children playing with the appliance are not required.
- ◆ Keep all ventilation openings in the enclosure or, in the structure for building in, clear of obstruction.
- ◆ Do not use mechanical devices or other means to accelerate the defrosting process, other than those recommended by the manufacturer.
- ◆ Do not damage the refrigerant circuit.
- ◆ Protection impairment if used in a manner not specified by the manufacturer.



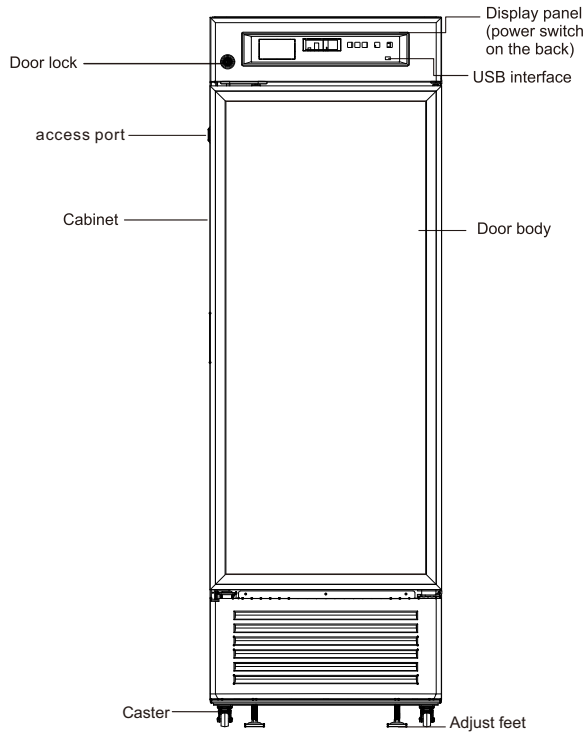

Model	Shelves	Loading capacity (kg)
YC-315L	4+1	25
YC-330L	5	20
YC-395L YC-395EL	6+1	25
YC-400L YC-400EL	6	22
YC-525L YC-525EL	6	32

Figure III YC-395L(It can be used as reference for YC-315L,YC-315EL,YC-330L,YC-330EL, YC-395EL, YC-400L, YC-400EL and YC-525L,YC-525EL)

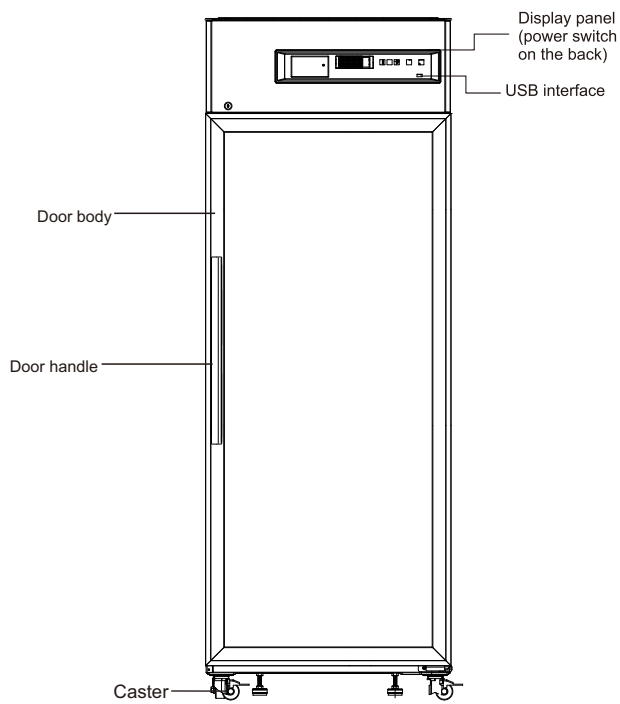

Model	Shelves	Loading capacity (kg)
YC-650L	5	36

Figure VI YC-650L

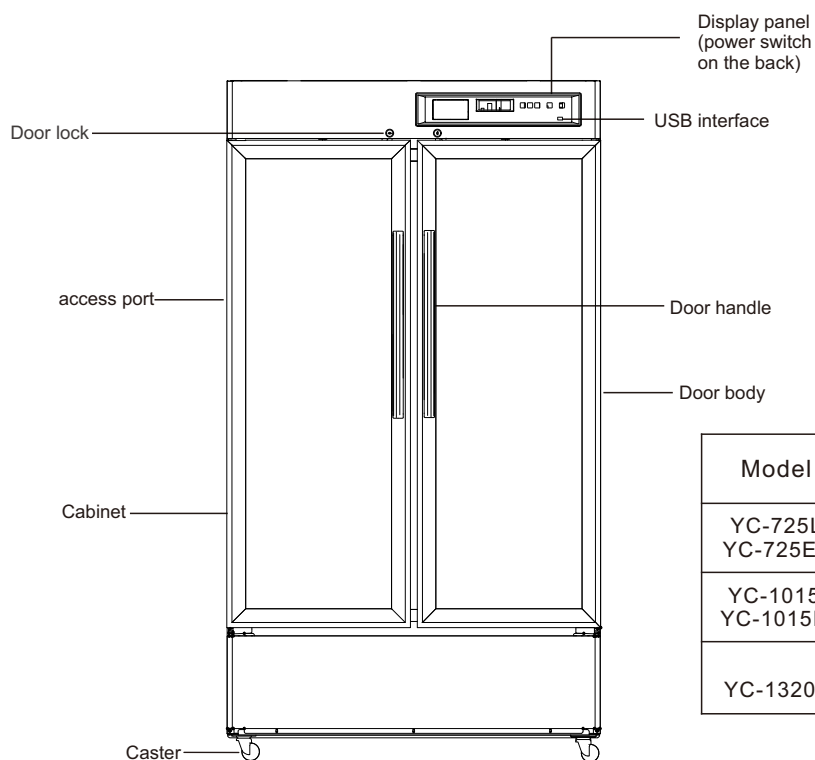

Model	Shelves	Loading capacity (kg)
YC-725L YC-725EL	12	21
YC-1015L YC-1015EL	12	27.5
YC-1320L	10	35

Figure V YC-725L (It can be used as reference for YC-725EL, YC-1015L, YC-1015EL, YC-1320L)

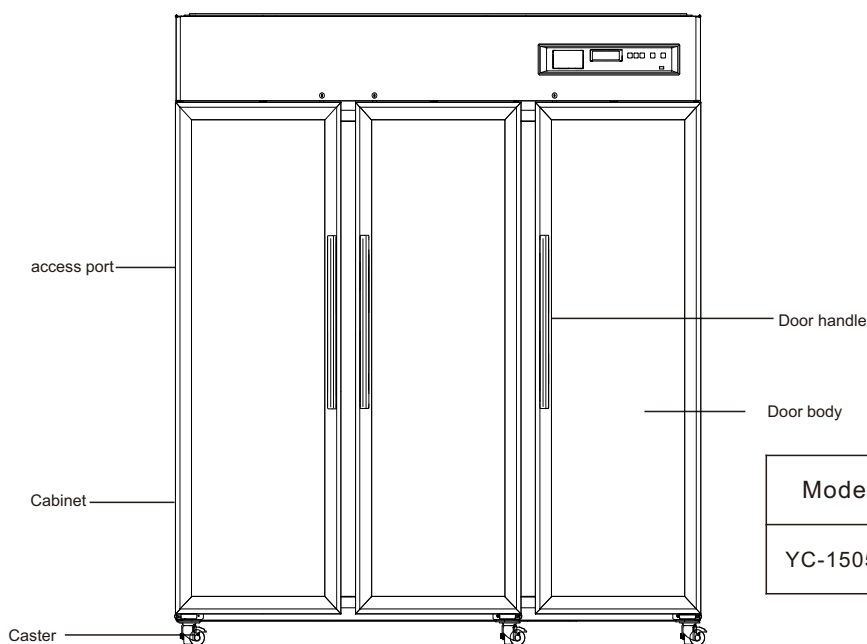

Model	Shelves	Loading capacity (kg)
YC-1505L	18	32

Figure IV YC-1505L

Except for the metal shell at the bottom, the contact time of the external accessible parts is  $t \geq 1$  min, while the contact time of the metal at the bottom is  $1 \text{ s} \leq t < 10 \text{ s}$ .

\* Due to the improvement of products and model differences, the actual products may be different from the diagram. Please refer to the actual products! The diagram is only used for functional parts description.

**Intended use:**

- \* Structure and composition: The product consists of cabinet, door (glass door structure or foam door structure), refrigeration system and control system.
- \* Scope of application: It is suitable for storing items in hospitals, pharmacies, epidemic prevention stations, research institutions, biopharmaceuticals and other units.

# 6. Operating Instructions

## 6.1 Function Introduction

This series of products include two control systems, based on which different adjustment methods apply. Please select the proper adjustment method according to the type of control system with the storage box you purchased.

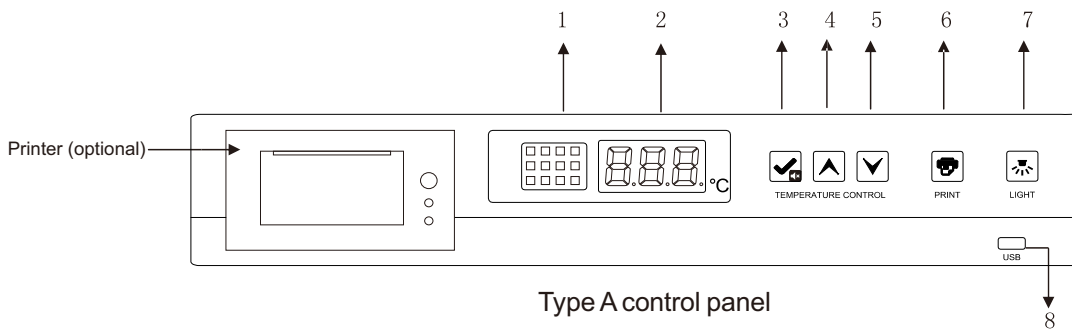

Type A control panel

### 1. Function description of Type A control panel (Except YC-130L,YC-130EL)

1) Description of display icon indicator (as shown in the right diagram);

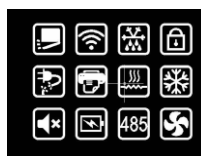

Door switch	WIFI	Defrosting	Key lock
Power failure	Print	Door heating	Refrigeration
Mute	Electric quantity	Serial port	Fan

a. Door switch indicator

When the door is opened, the door switch indicator is on; When the door is closed, the door switch indicator is off.

b. WIFI indicator

WIFI Pilot Lamp is on when WIFI is connected; it's off when WIFI is disconnected.

c. Defrosting indicator

When the refrigerator enters the defrosting state, the defrosting indicator is always on; When the refrigerator exits the defrosting state, the defrosting indicator is always off.

d. Key lock indicator

When the keys are in lock state, none of the keys respond, and the key lock lights up. In this case, after pressing the up key+down key for 3s, you will be prompted to enter the password, which is defaulted as "005." After entering it correctly, press the Set/Mute Multiplex key, and the key lock will be released. At this time, the key lock indicator will be off. In the unlock state, if no key is pressed for 60s, the key lock is started, and the key lock indicator is on. Long press the up key + down key for 3s, and the keys are locked.

e. Power-off indicator

The refrigerator is normally powered by 220V/110V. When the input power is turned off, the buzzer will be triggered, the digital tube flashes the power-off code "PF" alternately at 3s intervals, and the power-off indicator is on. When the input power is turned on, it returns to normal, and the power-off indicator is off.

f. Print indicator

When the printer is not working, the indicator is off; When the printer is working, the indicator is on.

g. Door heating indicator

When the door heating is turned off, the door heating indicator is off; When the door heating is turned on, the door heating indicator is on.

h. Refrigeration indicator

If the compressor is in working condition, the refrigeration indicator is on; If the compressor is in a shutdown state, the cooling indicator is off.

i. Mute indicator

When the alarm tone key is muted, the indicator is on; When the alarm mute function is canceled, the indicator is off.

j. Low battery level indicator

When the battery voltage is less than 8V, the buzzer will be triggered, the low battery indicator will be on, and the digital tube will flash the low battery code "BL" alternately at intervals of 3s; When the battery voltage is greater than 12V, the buzzer will be turned off, the low battery indicator will be off, and the digital tube will resume normal display.

k. Serial port indicator

When the reserved RS-485 serial port is not connected to the equipment, the serial port indicator will be off; When the equipment is successfully connected to the reserved RS-485 serial port, the serial port indicator will be on.





l. Fan indicator





When the evaporator fan is turned on, the fan indicator is on; when the evaporator fan is turned off, the fan indicator is off.

---



2)  temperature display window, which displays the average temperature inside the cabinet in °C under normal operation;



View ambient temperature:

In the key lock state, press  key, and digital tube displays the ambient temperature, and returns to normal display after 5 s without key operation, or pressing  and . In the key unlock state, press  key, and digital tube displays ambient temperature, and returns to normal display after 5s without key operation.

Humidity check: key unlocked state, long press  and , digital tube display humidity, no press any Key operation after 5 seconds or press  and , return to normal display.

3)  is the set/mute key;

In case of no alarm state and key unlock state, press , and display the ambient temperature for 5s and then return to normal display; In the unlock state, press  for more than 3s, and enter the user menu.

When buzzer is triggered (including cabinet high temperature alarm, door opening alarm, sensor failure alarm, etc.) and in the key unlock state, press  for the first time, and the buzzer stops ringing, and the ambient temperature is displayed for 5s, after which the normal display is resumed (pressing the mute button is only to turn off the buzzer for alarming this abnormal state, for example troubleshooting, and the buzzer will be triggered next time for any abnormality). Then press  again, trigger the buzzer, display the ambient temperature for 5s, and resume the display of chamber temperature and alarm state. In the key unlock state,  can be used as a setting key.

In unlock state and parameter setting mode, press this key to display parameter values and parameter names. If the pressing time is longer than 3 seconds, save the settings and return to the normal interface.

4)  is a up key;

In parameter setting mode, move to the next parameter or increase the parameter value. For example, when setting the set temperature, increase the set temperature value. When setting the parameter value, long press the up button, and the parameter will increase rapidly. Under normal conditions, long press the up key for 3 seconds to import the data of the USB flash drive in 12 months.

5)  is a down key;

In parameter setting mode, move to the previous parameter or decrease the parameter value.

For example, when setting the set temperature, reduce the set temperature.

When setting the parameter value, long press the down button, and the parameter will decrease rapidly.

6)  is a print key;

The system can keep 7 days of data for printing, and press the print key to print the temperature within the set time period.

7)  is a light switch key;

When the equipment is powered on, the lights are turned off by default.

8) USB data export;

Automatic export: when the U disk is connected to the USB interface, the recorder buzzer will chirp once and display "on". PDF files of data that not currently exported will be generated in the U disk. After data transmission, the buzzer will chirp once again and display "End".After 6s, it will return to normal display.

Note: When there is less data, the digital tube will not display "on" and "End".

Manual export: In the key unlock state, and when the USB flash drive is connected and the file is not being generated, press the key up for 3 seconds, and the digital tube will display "d01." Press the up key or down key to adjust "d00~d12," and press  key to obtain the file generation (d00) or generate the PDF file of the record data of the previous months (1-12).



## 2. Function setting of Type A control panel

1) After powering on, the equipment can enter the working state;

2) User parameter settings:

Unlock: under normal operating state, simultaneously press **▲** and **▼** keys for 3s and the digital tube will display the parameter code "0000"; By pressing **▲** to enter the password "0005" and holding **▼** to unlock. Then press **▼** key for 3s, the digital tube will display the parameter code "PS1" and enter the setting and adjustment parameters. Use **▲** or **▼** key to scroll the parameters;

a. Use **▲** or **▼** key to scroll the parameters;

b. Press **▼** key to display the corresponding parameter value;

c. Use **▲** or **▼** key to scroll the parameters;

d. Use **▼** to temporarily store the modified values and return to the display parameters;

e. If other parameters are modified, repeat steps ① to ④;

f. Press **▼** for more than 3s, save the modified parameters and return to the display parameter category.

3) Press **▼** for more than 3s, or press no key in 60s to exit the parameter setting program.

4) Parameter display

No.	Menu item	Parameter Range	Suggested settings	Remarks
1	MAX	—	—	The highest temperature since last clearance
2	MIN	—	—	The lowest temperature since last clearance
3	CLR	—	—	Clearance of the Max and Min temperature records
4	Set	0.0-10.0	5.0	Temperature setting
5	H	0.0-10.0	5.0	Set value of high temperature alarm set+H; When H =0, High temp alarm is disabled; When the alarm is over high temp alarm set, H1 will be displayed on the controller
6	L	0.0-10.0	5.0	Set value of low temperature alarm set-L; When L =0, Low temp alarm is disabled; When the alarm is below low temp alarm set, L1 will be displayed on the controller
7	n	Set logger module time - year	—	—
8	y	Set logger module time - month	—	—
9	r	Set logger module time - day	—	—
10	s	Set logger module time - hour	—	—
11	F	Set logger module time - minute	—	—
12	Pt	0-240min	20	Print interval
13	tH1	20.0-50.0℃	40.0	Upper limit of ambient temperature alarm

No.	Menuitem	Parameter Range	Suggested settings	Remarks
14	P1	1. Automatic heating mode 1 2. Automatic heating mode 2 3. Automatic heating mode 3 4. Always on 5. Always off	1. (Set to 4 when the door is with condensation) (Set to 1 when the door is a glass door) (Set to 5 when the door is a foaming door)	Mode 1: It shall be judged as once after the door is opened and closed once and heated for 5min (time setting). If the door is opened and closed again during the heating period, the heating time will be updated again; Mode 2: When the compressor runs, heater is on; When the compressor stops, the heater will automatically off after one min Mode 3: When the humidity in the cabinet is more than 80%, the door heating is on, and when the humidity in the cabinet is moderately less than 60%, the door heating is off; Mode 4: Door heating is always on; Mode 5: Door heating is always off.
15	Ps1	0000-9999	0005	User menu password settings
16	b1	—	—	Repair Information 1
17	b2	—	—	Repair Information 2

#### Quick setting of time after power on

After the power-on self-test on the display board is completed, the quick setting menu is displayed.

Menu item	Menu	Menu description	Set range	Default	Unit
Quick Settings menu	n	Set logger module time - year	10~50		/
	y	Set logger module time - month	1~12	--	/
	r	Set logger module time - day	01~31	--	/
	S	Set logger module time - hour	00~23	--	/
	F	Set logger module time - minute	00~59	--	/
	Pt	Print interval	0~240	20	min
	SCY	Temperature data recording period	0~240 0: shielded recorder	10	min

If there is no operation for 60 seconds under the quick setting menu, it will automatically exit the quick setting menu and return to normal display.





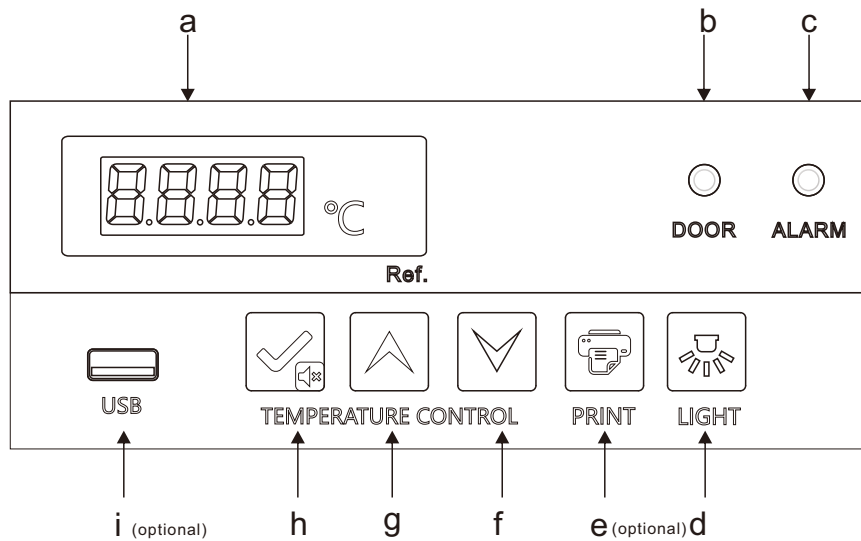



#### 4. Alarm display

Code	Error Description
H1	High temperature alarm
L1	Low temperature alarm
H2	Alarm for high ambient temperature
H3	Condenser overheat alarm
do	Door opening alarm
PF	Power failure alarm
bL	Battery low alarm
Er	The recorder is not connected
LoF	Recorder did not start
EE	Communication failure



Type B control panel

1. Function description of Type B control panel (Applicable to YC-130L YC-130EL)

- a. 4. 2 It is temperature display window, which displays the average temperature inside the cabinet in °C under normal operation; Different prompt characters can be displayed in the setting state (see below for details).
- b. Door opening indicator: When the refrigerator door is opened, the indicator lights up. After more than 1 minute, the door opening alarm indicator will be on and the buzzer triggered, displaying "do".
- c. Fault indicator: When the product runs normally, the indicator is off; The indicator is on for operation abnormality.
- d. "LIGHT" : After the machine is powered on, the light is off by default, and the on-off of the light can be adjusted by the on-off key.
- e. "PRINT " (optional): The system can keep 7 days of data for printing. Press the print key to print the temperature within the set time period.
- f. : In parameter setting mode, reduce the parameter value. For example, when setting the set temperature, reduce the set temperature. When setting the parameter value, long press the down button, and the parameter will decrease rapidly.
- g. : In parameter setting mode, increase the parameter value. For example, when setting the set temperature, increase the set temperature value. When setting the parameter value, long press the up button, and the parameter will increase rapidly. Under normal conditions, long press the up key for 3 seconds to import the data of the USB flash drive in 12 months.
- h. : is the set/mute key; In case of no alarm state and key unlock state, press , and display the ambient temperature for 5s and then return to normal display; In the unlock state, press  for more than 3s, and enter the user menu.
- When buzzer is triggered (including cabinet high alarm, door opening alarm, sensor failure alarm, etc.) and in the button unlock state, press  for the first time, and the buzzer stops ringing, and the ambient temperature is displayed for 5s, after which the normal display is resumed (pressing the mute button is only to turn off the buzzer for alarming this abnormal state, for example trouble removal, and the buzzer will be triggered next time for any abnormality). Then press  again, trigger the buzzer, display the ambient temperature for 5s, and then resume the display of cabinet temperature and alarm state. In the key unlock state,  can be used as a setting key.

In unlock state and parameter setting mode, press this key to display parameter values and parameter names. If the pressing time is longer than 3 seconds, save the settings and return to the normal interface.



i. USB interface

Automatic export of USB data: When the USB interface is connected to the USB flash drive, the buzzer of the recorder beeps once, displaying "ON", and PDF files of the data of the current month and the previous month are generated in the USB flash drive. After the data transmission is completed, the buzzer beeps once, displaying "End," and the normal display resumes after 6s.

**!** **Note:** When there is less data, "on" and "end" prompts are not displayed.

Manual export of USB data: In the key unlock state, when the USB flash drive is connected and the file is not being generated, press the up key for 3 seconds, and the digital tube in the lower chamber will display "d01." Press the key up or down key to adjust "d00~d12," and press  key to cancel the file generation (d00) or generate the PDF file of the record data of the previous months (1-12).







**!** **Note:** When the alarm of the digital tube flashes and displays "LoF," the recorder is not started;

Meanwhile press  and  key for 3s, and "LoF" disappears, the recorder is started.

## 2. Function setting of Type A control panel



1) After powering on, the equipment can enter the working state;

2) User parameter settings:

Unlock: under normal operating state, simultaneously press  and  keys for 3s and the digital tube will display the parameter code "0000"; By pressing  to enter the password "0005" and holding  to unlock. Then press  key for 3s, the digital tube will display the parameter code "PS1" and enter the setting and adjustment parameters. Use  or  key to scroll the parameters;

a. Use  or  key to scroll the parameters;

b. Press  key to display the corresponding parameter value;

c. Use  or  key to scroll the parameters;

d. Use  to temporarily store the modified values and return to the display parameters;

e. If other parameters are modified, repeat steps ① to ④;

3) Press  for more than 3s, save the modified parameters and return to the display parameter category.

4) Press  for more than 3s, or press no key in 60s to exit the parameter setting program.

### 3. Parameter display

No.	Menuitem	Parameter Range	Suggested settings	Remarks
1	MAX	–	–	The highest temperature since last clearance
2	MIN	–	–	The lowest temperature since last clearance
3	CLR	–	–	Clearance of the Max and Min temperature records
4	Set	0.0-10.0	5.0	Temperature setting
5	H	0.0-10.0	5.0	Set value of high temperature alarm set+H; When H =0, High temp alarm is disabled; When the alarm is over high temp alarm set, H1 will be displayed on the controller
6	L	0.0-10.0	5.0	Set value of low temperature alarm set-L; When L =0, Low temp alarm is disabled; When the alarm is below low temp alarm set, L1 will be displayed on the controller
7	n	Set logger module time - year	–	–
8	y	Set logger module time - month	–	–
9	r	Set logger module time - day	–	–
10	s	Set logger module time - hour	–	–
11	F	Set logger module time - minute	–	–
12	Pt	0-240min	20	Print interval
13	tH1	20.0-50.0°C	40.0	Upper limit of ambient temperature alarm
14	P1	1. Automatic heating mode 1 2. Automatic heating mode 2 3. Automatic heating mode 3 4. Always on 5. Always off	1. (Set to 4 when the door is with condensation) (Set to 1 when the door is a glass door) (Set to 5 when the door is a foaming door)	Mode 1: It shall be judged as once after the door is opened and closed once and heated for 5min (time setting). If the door is opened and closed again during the heating period, the heating time will be updated again; Mode 2: When the compressor runs, heater is on; When the compressor stops, the heater will automatically off after one min Mode 3: When the humidity in the cabinet is more than 80%, the door heating is on, and when the humidity in the cabinet is moderately less than 60%, the door heating is off; Mode 4: Door heating is always on; Mode 5: Door heating is always off.
15	Ps1	0000-9999	0005	User menu password settings
16	b1	–	–	Repair Information 1
17	b2	–	–	Repair Information 2

Quick setting of time after power on

After the power-on self-test on the display board is completed, the quick setting menu is displayed.

Menu item	Menu	Menu description	Set range	Default	Unit
Quick Settings menu	n	Set logger module time - year	10~50		/
	y	Set logger module time - month	1~12	--	/
	r	Set logger module time - day	01~31	--	/
	S	Set logger module time - hour	00~23	--	/
	F	Set logger module time - minute	00~59	--	/
	Pt	Print interval	0~240	20	min
	SCY	Temperature data recording period	0~240 0: shielded recorder	10	min

If there is no operation for 60 seconds under the quick setting menu, it will automatically exit the quick setting menu and return to normal display.

#### 4. Alarm display

Alarm Code	Error Description
H1	High temperature alarm
L1	Low temperature alarm
H2	High ambient temperature alarm
H3	Condenser overheat alarm
do	Door opening alarm
PF	Power failure alarm
bL	Battery low alarm
Er	The recorder is not connected
LoF	Recorder did not start
EE	Communication failure

## 6.2 Optional function

### 6.2.1 Printer

The printer has been installed with a paper roll at the factory. If the paper roll is used up after a long period of use, you can buy the same paper roll (size: thermal paper, paper width:  $57.5 \pm 0.5$ mm, the outer diameter of the reel: not greater than 40mm, i.e., RM57\*40 back-roll paper)

Description of printer panel:

- ① Open button. Press to open the cover;
- ② SEL button, indicator light, for factory setting. Do not press it;
- ③ Lf button. The green indicator is the power indicator and it is normally on when the power is turned on;
- ④ Paper roll

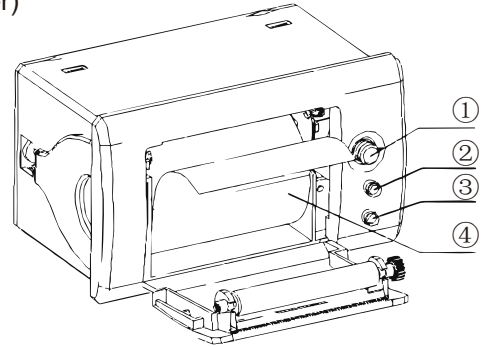

Install the paper roll:

Press the open button 1, open the cover, install the paper roll, close the cover plate and allow the head of the roll paper to slightly extend out of the cover plate.

### 6.2.2 Remote alarm terminal, RS485 interface and network interface

Remote alarm terminal, RS485 interface and network interface are installed in the lower part of the back of the freezer body.

Note: These configurations are standard for some models.

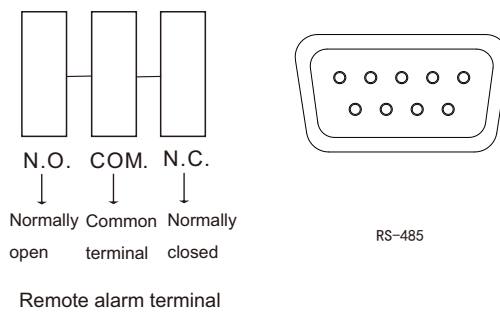

### 6.2.3 Chart recorder

It is an optional function. If the function is selected, please refer to the "Operation Instructions for Graph Recorder" in the accessory bag.

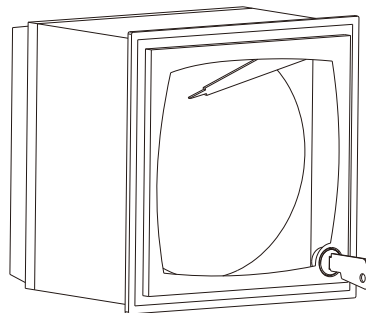

Chart recorder









Model	Ambient temperature (°C)	Climate type	Refrigerant and loading amount	(Rated) voltage (V~)	Rated frequency (Hz)	Temp Range (°C)	Volume (L)	(Rated) current (A)	Weight (kg)	Exterior dimensions (DxWxH) (mm)
YC-55L (Spraying aluminum liner)	16~32	N	R600a/ 18g	110	60	2~8	55	1.16	35	560X540X632
YC-55L (Stainless steelliner)	16~32	N	R600a/ 18g	110	60	2~8	55	1.16	38	560X540X632
YC-55EL (Spraying aluminum liner)	16~32	N	R600a/ 18g	110	60	2~8	55	0.79	32	560X540X632
YC-55EL (Stainless steelliner)	16~32	N	R600a/ 18g	110	60	2~8	55	0.79	35	560X540X632
YC-56L (Spraying aluminum liner)	16~32	N	R600a/ 18g	110	60	2~8	56	1.16	35	565X542X632
YC-56L (Stainless steelliner)	16~32	N	R600a/ 18g	110	60	2~8	56	1.16	38	565X542X632
YC-56EL (Spraying aluminum liner)	16~32	N	R600a/ 18g	110	60	2~8	56	0.79	32	565X542X632
YC-56EL (Stainless steelliner)	16~32	N	R600a/ 18g	110	60	2~8	56	0.79	35	565X542X632
YC-75L (Spraying aluminum liner)	16~32	N	R600a/ 18g	110	60	2~8	75	1.24	41	560X540X764
YC-75L (Stainless steelliner)	16~32	N	R600a/ 18g	110	60	2~8	75	1.24	45	560X540X764
YC-75EL (Spraying aluminum liner)	16~32	N	R600a/ 18g	110	60	2~8	75	0.85	35	560X540X764
YC-75EL (Stainless steelliner)	16~32	N	R600a/ 18g	110	60	2~8	75	0.85	39	560X540X764
YC-76L (Spraying aluminum liner)	16~32	N	R600a/ 18g	110	60	2~8	76	1.24	41	566X542X764
YC-76L (Stainless steelliner)	16~32	N	R600a/ 18g	110	60	2~8	76	1.24	45	566X542X764
YC-76EL (Spraying aluminum liner)	16~32	N	R600a/ 18g	110	60	2~8	76	0.85	35	566X542X764
YC-76EL (Stainless steelliner)	16~32	N	R600a/ 18g	110	60	2~8	76	0.85	39	566X542X764
YC-130L (Spraying aluminum liner)	16~32	N	R290/ 26g	110	60	2~8	130	2.28	51	625X650X810
YC-130L (HIPS)	16~32	N	R290/ 26g	110	60	2~8	130	2.28	50	625X650X810
YC-130EL (Spraying aluminum liner)	16~32	N	R290/ 26g	110	60	2~8	130	1.66	45	625X650X810
YC-130EL (HIPS)	16~32	N	R290/26g	110	60	2~8	130	1.66	44	625X650X810
YC-315L	16~32	N	R290/60g	110	60	2~8	315	3.83	87	673X650X1762
YC-315EL	16~32	N	R290/60g	110	60	2~8	315	3.45	83	673X650X1762
YC-395L (Compressor A)	16~32	N	R290/60g	110	60	2~8	395	3.77	95	673X650X1992
YC-395L (Compressor B)	16~32	N	R290/60g	110	60	2~8	395	4.76	95	673X650X1992
YC-395EL (Compressor A)	16~32	N	R290/60g	110	60	2~8	395	3.77	93	652X650X1992
YC-395EL (Compressor B)	16~32	N	R290/60g	110	60	2~8	395	4.76	93	652X650X1992
YC-400L	16~32	N	R290/55g	110	60	2~8	400	4.74	116	645X700X2010
YC-400EL	16~32	N	R290/55g	110	60	2~8	400	3.52	107	645X700X2010

Model	Ambient temperature (°C)	Climate type	Refrigerant and loading amount	(Rated) voltage (V~)	Rated frequency (Hz)	Temp Range (°C)	Volume (L)	(Rated) current (A)	Weight (kg)	Exterior dimensions (DxWxH) (mm)
YC-525L (Spraying aluminum liner)	16~32	N	R290/75g	110	60	2~8	525	5.1	141	810X720X1973
YC-525L (Stainless steel liner)	16~32	N	R290/75g	110	60	2~8	525	5.1	148	810X720X1973
YC-525EL (Spraying aluminum liner)	16~32	N	R290/75g	110	60	2~8	525	3.84	127	810X720X1973
YC-525EL (Stainless steel liner)	16~32	N	R290/75g	110	60	2~8	525	3.84	134	810X720X1973
YC-650L (Spraying aluminum liner) (Compressor A)	16~32	N	R290/ 110g	110	60	2~8	650	5.77	142	890X715X1985
YC-650L (Stainless steel liner) (Compressor A)	16~32	N	R290/ 110g	110	60	2~8	650	5.77	157	890X715X1985
YC-650L (Spraying aluminum liner) (Compressor B)	16~32	N	R290/ 80g	110	60	2~8	650	5.77	142	890X715X1985
YC-650L (Stainless steel liner) (Compressor B)	16~32	N	R290/ 80g	110	60	2~8	650	5.77	157	890X715X1985
YC-725L (Spraying aluminum liner)	16~32	N	R134a/ 245g	110	60	2~8	725	8	171	718X1093X1992
YC-725L (Stainless steel liner)	16~32	N	R134a/ 245g	110	60	2~8	725	8	189	718X1093X1992
YC-725EL (Spraying aluminum liner)	16~32	N	R134a/ 245g	110	60	2~8	725	6.92	161	718X1093X1992
YC-725EL (Stainless steel liner)	16~32	N	R134a/ 245g	110	60	2~8	725	6.92	179	718X1093X1992
YC-1015L (Spraying aluminum liner)	16~32	N	R134a/ 280g	110	60	2~8	1015	8.2	185	852X1180X1990
YC-1015L (Stainless steel liner)	16~32	N	R134a/ 280g	110	60	2~8	1015	8.2	223	852X1180X1990
YC-1015EL (Spraying aluminum liner)	16~32	N	R134a/ 280g	110	60	2~8	1015	7.09	173	852X1180X1990
YC-1015EL (Stainless steel liner)	16~32	N	R134a/ 280g	110	60	2~8	1015	7.09	202	852X1180X1990
YC-1320L (Spraying aluminum liner)	16~32	N	R290/ 150g	110	60	2~8	1320	10.55	235	826X1453X1998
YC-1320L (Stainless steel liner)	16~32	N	R290/ 150g	110	60	2~8	1320	10.55	258	826X1453X1998

Model	Ambient temperature (°C)	Climate type	Refrigerant and loading amount	(Rated) voltage (V~)	Rated frequency (Hz)	Temp Range (°C)	Volume (L)	(Rated) current (A)	Weight (kg)	Exterior dimensions (DxWxH) (mm)
YC-55L YC-55EL (Spraying aluminum liner)	16~32	N	R600a/16g	220-240	50	2~8	55	0.9	35	560X540X632
YC-55L YC-55EL (Stainless steel liner)	16~32	N	R600a/16g	220-240	50	2~8	55	0.9	38	560X540X632
YC-56L (Spraying aluminum liner)	16~32	N	R600a/16g	220-240	50	2~8	56	0.9	35	565X542X632
YC-56EL (Spraying aluminum liner)	16~32	N	R600a/16g	220-240	50	2~8	56	0.9	32	565X542X632
YC-56L (Stainless steel liner)	16~32	N	R600a/16g	220-240	50	2~8	56	0.9	38	565X542X632
YC-56EL (Stainless steel liner)	16~32	N	R600a/16g	220-240	50	2~8	56	0.9	35	565X542X632
YC-75L YC-75EL (Spraying aluminum liner)	16~32	N	R600a/18g	220-240	50	2~8	75	0.92	41	560X540X764
YC-75L YC-75EL (Stainless steel liner)	16~32	N	R600a/18g	220-240	50	2~8	75	0.92	45	560X540X764
YC-76L (Spraying aluminum liner)	16~32	N	R600a/18g	220-240	50	2~8	76	0.92	41	566X542X764
YC-76EL (Spraying aluminum liner)	16~32	N	R600a/18g	220-240	50	2~8	76	0.92	35	566X542X764
YC-76L (Stainless steel liner)	16~32	N	R600a/18g	220-240	50	2~8	76	0.92	45	566X542X764
YC-76EL (Stainless steel liner)	16~32	N	R600a/18g	220-240	50	2~8	76	0.92	39	566X542X764
YC-130L YC-130EL (Spraying aluminum liner)	16~32	N	R600a/55g	220-240	50	2~8	130	0.98	51	625X650X810
YC-130L YC-130EL (Stainless steel liner)	16~32	N	R600a/55g	220-240	50	2~8	130	0.98	57	625X650X810
YC-315L (HIPS)	16~32	N	R600a/22g	220-240	50	2~8	315	1.35	87	652X650X1762
YC-315EL (HIPS)	16~32	N	R600a/22g	220-240	50	2~8	315	1.35	87	652X650X1762
YC-330L YC-330EL (Spraying aluminum liner)	16~32	N	R600a/50g	220-240	50	2~8	330	1.31	76	592X620X1937
YC-330L YC-330EL (Stainless steel liner)	16~32	N	R600a/50g	220-240	50	2~8	330	1.31	81	592X620X1937
YC-395L (HIPS)	16~32	N	R600a/25g	220-240	50	2~8	395	1.8	95	673X650X1992
YC-395EL (HIPS)	16~32	N	R600a/25g	220-240	50	2~8	395	1.8	95	652X650X1992
YC-525L YC-525EL (Spraying aluminum liner)	16~32	N	R290/70g	220-240	50	2~8	525	2.49	141	810X720X1973
YC-525L YC-525EL (Stainless steel liner)	16~32	N	R290/70g	220-240	50	2~8	525	2.49	148	810X720X1973
YC-725L YC-725EL (Spraying aluminum liner)	16~32	N	R290/85g	220-240	50	2~8	725	3.90	171	718X1093X1992
YC-725L YC-725EL (Stainless steel liner)	16~32	N	R290/85g	220-240	50	2~8	725	3.90	189	718X1093X1992
YC-1015L (Stainless steel liner)	16~32	N	R290/90g	220-230	50	2~8	1015	3.21	223	852X1180X1990
YC-1015L (Spraying aluminum liner)	16~32	N	R290/90g	220-230	50	2~8	1015	3.21	185	852X1180X1990

Model	Ambient temperature (°C)	Climate type	Refrigerant and loading amount	(Rated) voltage (V~)	Rated frequency (Hz)	Temp Range (°C)	Volume (L)	(Rated) current (A)	Weight (kg)	Exterior dimensions (DxWxH) (mm)
YC-130L (Spraying aluminum liner) (without disc recorder)	16~32	N	R134a/110g	220-240	50/60	2~8	130	1.1	51	625X650X810
YC-130L (Stainless steel liner) (without disc recorder)	16~32	N	R134a/110g	220-240	50/60	2~8	130	1.1	57	625X650X810
YC-130L (Spraying aluminum liner) (with disc recorder)	16~32	N	R134a/110g	220-240	50/60	2~8	130	1.1	51	625X650X920
YC-130L (Stainless steel liner) (with disc recorder)	16~32	N	R134a/110g	220-240	50/60	2~8	130	1.1	57	625X650X920
YC-315L (HIPS)	16~32	N	R290/25g	220-240	50/60	2~8	315	1.77	87	673X650X1762
YC-395L (HIPS)	16~32	N	R290/28g	220-240	50/60	2~8	395	1.39	95	673X650X1992
YC-400L (Spraying aluminum liner)	16~32	N	R290/65g	220-240	50/60	2~8	400	2.23	110	645X700X2010
YC-400L (Stainless steel liner)	16~32	N	R290/65g	220-240	50/60	2~8	400	2.23	116	645X700X2010
YC-525L (Spraying aluminum liner)	16~32	N	R290/80g	220-240	50/60	2~8	525	2.17	141	810X720X1973
YC-525L (Stainless steel liner)	16~32	N	R290/80g	220-240	50/60	2~8	525	2.17	148	810X720X1973
YC-650L (Spraying aluminum liner) (Compressor A)	16~32	N	R290/105g	220-240	50/60	2~8	650	3.06	142	890X715X1985
YC-650L (Spraying aluminum liner) (Compressor B)	16~32	N	R290/85g	220-240	50/60	2~8	650	3.06	142	890X715X1985
YC-650L (Stainless steel liner) (Compressor A)	16~32	N	R290/105g	220-240	50/60	2~8	650	3.06	157	890X715X1985
YC-650L (Stainless steel liner) (Compressor B)	16~32	N	R290/85g	220-240	50/60	2~8	650	3.06	157	890X715X1985
YC-725L (Spraying aluminum liner)	16~32	N	R290/90g	220-240	50/60	2~8	725	3.9	171	718X1093X1992
YC-725L (Stainless steel liner)	16~32	N	R290/90g	220-240	50/60	2~8	725	3.9	189	718X1093X1992
YC-1015L (Spraying aluminum liner)	16~32	N	R290/90g	220-240	50/60	2~8	1015	3.78	185	852X1180X1990
YC-1015L (Stainless steel liner)	16~32	N	R290/90g	220-240	50/60	2~8	1015	3.78	223	852X1180X1990
YC-1320L (Spraying aluminum liner)	16~32	N	R290/150g	220-240	50/60	2~8	1320	6.2	235	826X1453X1998
YC-1320L (Stainless steel liner)	16~32	N	R290/150g	220-240	50/60	2~8	1320	6.2	258	826X1453X1998
YC-1505L (Stainless steel liner)	16~32	N	R290/150g	220-240	50/60	2~8	1505	5.2	322	832X1798X1997

\* The foaming material of this product is cyclopentane.





Zhongke Meiling Cryogenics Company Limited  
Address: No 1862 Zishi Road, Hefei City, Anhui, P.R. China  
Production Address: No.1862 Zishi Road, Economic and  
Technological Development Zone, Hefei City  
Post Code: 230601  
Material Code: 890375561  
Email: [zkmeiling@zkmeiling.com](mailto:zkmeiling@zkmeiling.com); [technical.service@zkmeiling.com](mailto:technical.service@zkmeiling.com)  
Website: [www.melingbiomedical.com](http://www.melingbiomedical.com)  
Production Date: See nameplate on the freezer body  
Prepared in: August 2023