



Combined Refrigerator and Freezer

Operation Manual

The following product models are applicable:

YCD-FL289

YCD-EL300

YCD-EL450

YCD-FL450

YCD-FL519



Better science, Better life!

www.melingbiomedical.com











zkmeiling@zkmeiling.com











Table of Contents





















1. Application Notes	1
2. Safety Instructions	2
3. Precautions in Use	4
4. Product Installation	4
4.1 Installation Environment	4
4.2 Installation Site	4
4.3 Preparation before Use	5
4.4 First Power-on	5
4.5 Operation after Power Failure	5
5. Component Composition	6
6. Operating Instructions	7
7. Defrost, Discontinuation and Maintenance	14
7.1 Equipment Maintenance	14
7.2 Equipment Discontinuation	14
8. Troubleshooting and Maintenance Services	15
9. Specifications	16
10. Accessories	17

2. Safety Instructions ■■■■■.

When using this product for the first time, please pay attention to the meaning of the following warning signs and carefully read the safety precautions, so that you can use this equipment safely and correctly.

 Warning! Failure to observe the precautions may result in serious personal injury or death.	 Attention! Failure to observe the precautions may result in personal injury or equipment failure and related property losses
 Must be grounded	 Risk of Explosion This sign indicates the risk of explosion when using volatile and explosive chemicals.
 Do not place it obliquely	 Avoid direct sunlight
 Beware of electric shock.	 Beware of low temperature
 Beware of fire.Warning;flammable material	 This equipment is a precision instrument
 Warning; crushing of hands.	

 Warning: Risk of fire/flammable materials.
 Warning: Failure to observe the precautions may result in serious personal injury or death.
 Do not touch the equipment with wet hands to avoid electric shock; Equipment shall not be grounded through gas pipeline, water supply pipeline, telephone line or lightning rod, which may easily cause electric shock.
 This equipment can only be installed by professional technicians or after-sales maintenance personnel, it may cause electric shock or fire.
 Be sure to install the equipment on a solid and flat ground and take due care to prevent tipping over. If the ground is not solid enough or the installation location is not appropriate, it may cause the equipment to fall over and cause equipment damage or personal injury.
 Please handle the power cord carefully to avoid short circuits or open circuits. Please turn off the power before pulling out the power plug. Hold the power plug carefully and pull it out. Do not pull the wires of the power plug. Otherwise, it may cause electric shock or fire due to the short circuit. Don't bundle the power cord, don't press it under furniture or heavy objects, and don't get close to heat sources such as compressors.
 Please insert the power plug into the outlet tightly to ensure firmness and reliability, so as to avoid electric leakage; After installation, the power plug must be within reach, so that the power cord can be unplugged in time in case of emergency.
 Separate special outlets must be used and grounded reliably. The cross-sectional area of the copper conductor in the wall connected with the outlet must be more than 4mm ² . Do not lengthen the power cord without authorization to avoid heating or fire.
 Do not use the power supply that is not specified in the equipment design, so as to avoid overheating, short circuit and other faults. For example, connecting 110V rated voltage products to 220V power supply may cause faults such as overheating and equipment burning. For detailed input voltage AC please refer to Specification(Rated voltage ±10%).If the operating voltage is too low or too high, a suitable automatic voltage stabilizer must be installed for cooperative use.
 Please place the equipment stably and avoid shaking.
 Do not place the equipment in a dangerous area, and do not operate the equipment near flammable items to prevent explosion or fire accidents.

	Vents and drains are located at the bottom of the equipment. It is forbidden to place items at the bottom of the cabinet.
	Do not place the equipment in areas exposed to the sun or rain, so as to prevent danger such as short circuit or overheating.
	Do not tilt or lay the equipment sideways, and do not impact the equipment body; Refrigeration systems are installed in the equipment, which is easy to be damaged by tilt or impact.
	Please place the equipment in a dry and dust-free environment to avoid risks such as overheating, and short circuit.
	In case of unexpected sound, smell, smoke, etc. when the power is turned on, please unplug the power in time and contact the manufacturer or supplier.
	Please place the equipment in a dry and ventilated environment, and ensure that the equipment vents and instrument surfaces are not blocked or shielded by walls or other objects; Do not use it in a poorly ventilated environment to prevent damage caused by heat released by equipment.
	It is forbidden to disassemble and modify this equipment without authorization, so as to avoid potential safety hazards. In this case, MELING BIOMEDICAL will not bear any responsibility for quality accidents.
	It is forbidden to put inflammable and explosive dangerous goods, strong corrosive acids, alkalis and other items unsuitable for the equipment in the equipment.
	When storing toxic, harmful or radioactive materials, please use the equipment in safe areas. Improper use may cause harm to human health or environment.
	Metal objects such as nails or iron wires shall not be inserted into any aperture and gap or any outlet of the equipment, otherwise electric shock or injury may be caused due to accidental contact between the above objects and moving parts.
	In order to ensure the normal operation and ventilation and heat dissipation of the equipment, the back, left and right sides of the cabinet body should be at least 30cm away from the wall, and the air inlet and air outlet must not be blocked by obstacles.
	This equipment must be connected to a ground wire.
	Note: Failure to observe the precautions may result in personal injury or equipment failure and related property losses.
	It is forbidden to store living animals, flowers or other items with strict temperature requirements in the equipment.
	When the equipment is running, do not touch the inner surface of the cabinet without wearing protective gear.
	Hold the handle and close the door to avoid pinching your fingers; When the equipment is not used for a long time, please unplug it and pack it for storage.
	When restarting the equipment after power failure or power off, please check the equipment settings first, otherwise the stored items may be damaged due to the change of settings.
	The equipment can be used for item preservation, not as production equipment.
	Keep the keys properly, so as to avoid accidents when children open the door accidentally.
	When handling the equipment, please be careful not to tip over the equipment, so as to prevent equipment damage or personal injury.
	When handling, it shall be lifted from the bottom, with the inclined plane not be greater than 45°, and it shall be handled with care. Please use the equipment in safe areas. Improper use may cause harm to human health or environment.



Attention: Since the ambient temperature has great influence on the equipment, if the above environmental requirements cannot be met, the equipment may not run normally. Please improve the environment before using the equipment; The equipment is operated intermittently.

4.3 Preparation Before Use

1. Remove the outer packaging of all products (including the protective foam in the packaging box)



Warning: Don't put the plastic bags within the reach of children, so as to prevent suffocation accidents.

2. Inventory of accessories: Please check the accessories and materials according to the packing list.
3. Cleaning: Clean the product once before use.

4.4 First Power-on

When using the equipment for the first time, please follow these steps:

1. After the equipment is placed, leveled and cleaned, it shall stand for more than 24 hours, and then power it on to ensure the normal operation of the equipment.
2. Under no-load condition, connect the power cord to a special outlet with appropriate specifications.
3. After powering on, turn on the power switch of the equipment.
4. Check whether the operating temperature of the equipment reaches the required value, observe the normal start and stop of the equipment for more than 24 hours, and put a small amount of items in the equipment after confirming the normal performance.
5. Please store items in batches, with the items not exceeding 1/3 of the cabinet body volume each time. Ensure that the equipment is running properly after shutdown for more than 12 hours before putting in the next batch of items).
6. Try not to open the door during cooling, otherwise the temperature will rise.

4.5 Operation after Power Failure

1. The equipment has a memory function for the set value. When the power is restored after power failure, the equipment will continue to operate before power failure.
2. Once the equipment is powered off, it requires 5 minutes before it can be switched on again, so as to avoid damaging the compressor.
3. We guarantee the normal operation of this equipment under certain conditions, but we are not responsible for any loss or damage of stored items after power failure.



Notes:

- ◆ The transportation and movement of equipment is realized by casters.
- ◆ A special person shall be responsible for checking and recording the running status of the equipment every day (record and check once every 2-4 hours). In case of failure or shutdown, the temperature in the storage chamber will rise. If it cannot be repaired in a short time, please take out the stored items and transfer them to a place that meets the temperature requirements for storage to avoid damage to the items.
- ◆ Before putting items into the equipment, it shall be confirmed in advance whether the temperature range of the equipment meets the temperature requirement of the items, so as to avoid damage to stored items due to the difference between the settable temperature of the equipment and the required temperature of the items. Please pay attention not to block the air outlet and air inlet when putting items into the equipment.
- ◆ Due to the refrigeration inertia, there is a certain difference between the actual display temperature and the set temperature of the equipment, which is a normal phenomenon.
- ◆ The equipment is an item storage equipment, which cannot be used for routine production operations. It is strictly forbidden to put too many items which are relatively hot into the equipment at one time, otherwise the compressor will run for a long time, and be burned due to high temperature. Items must be put in batches, so as to ensure that the storage chamber is cooled step by step until the temperature required for storing items is reached.
- ◆ Electrical appliances without production license shall not be used inside the equipment.
- ◆ Do not change the set temperature frequently in a short time, otherwise the expected setting effect may not be achieved due to the large temperature inertia; Ensure that there is a certain air circulation space around the cabinet when putting in items, especially do not block the temperature sensor in the cabinet (for collecting the temperature of the cabinet), otherwise it will affect the stability and accurate control of the temperature in the cabinet body.
- ◆ Items shall not be placed directly at the bottom of the equipment, but on the bottom shelf, otherwise the refrigeration effect of the equipment will be affected.
- ◆ When putting in items, if the moisture content of the items is too much or too little, it will affect the humidity change in the cabinet, so it is best to keep the items sealed; The humidity of the working environment will affect the change of humidity in the cabinet, especially if the door is opened too frequently and the door is not closed properly.



Warning: Children are not allowed to play with this equipment as a game prop, otherwise the injury or loss caused therefrom will be at their own risk.

5. Component Composition

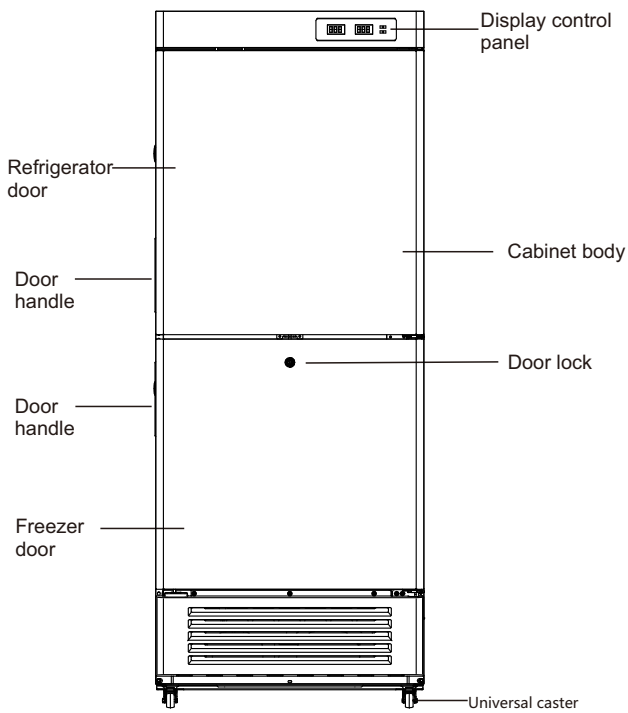

YCD-EL300

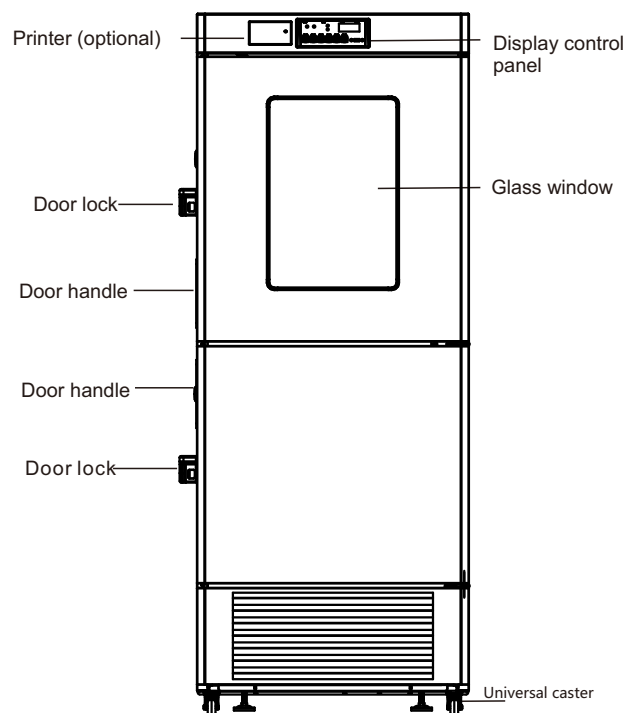

YCD-FL289 (It can be used as reference for YCD-FL519)

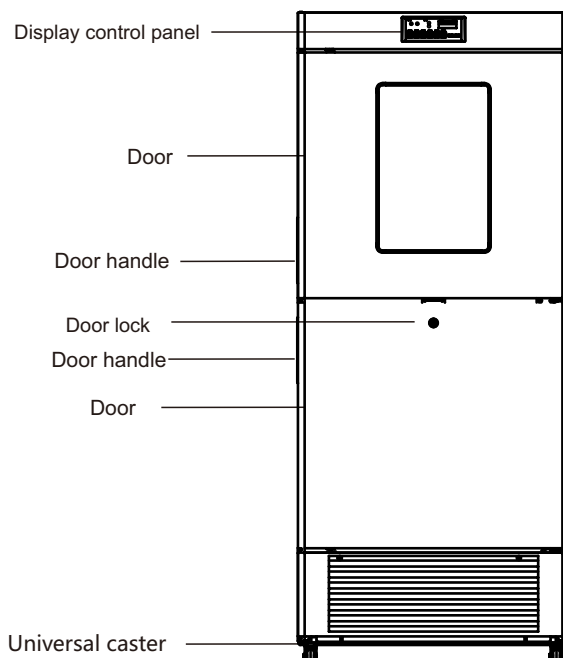

YCD-EL450 (It can be used as a reference for YCD-EL450 and YCD-FL450)

- * The YCD-FL289 freezer has six shelves, each with capacity of 21 Kg;
- * The YCD-EL300 freezer has six shelves, each with capacity of 23 Kg;
- * The YCD-EL450/YCD-FL450 freezer has six shelves, each with capacity of 29 Kg;
- * The YCD-FL519 freezer has six shelves, each with capacity of 34 Kg.

2. Function setting of Type A control panel

- 1) After powering on, the equipment can enter the working state;
- 2) User parameter settings: In measurement and control state, press SET key, and the digital tube will flash and display temperature value currently set, enter the user parameter settings state, press ▲ or ▼ key to adjust the set temperature, long press ▲ or ▼ key to make the set temperature value in an increasing or decreasing succession, press SET key or no operation within 5s to save parameters and return to measurement and control state.
- 3) On and off: in the measurement and control state, press ▼ key for 3s to turn off the display and output control, and enter the power-off state (you can turn off the refrigerator chamber or freezer chamber separately). Press any key to turn on the display and output control, and return to the measurement and control state.

4) Parameter display

Alarm Code	Default Description
E1	Refrigerator sensor failure
E2	Freezer sensor failure
dA	Door ajar alarm



Note: in case of high and low temperature alarm, the buzzer will sound and the digital tube will flash to display the current temperature. In data failure, sensor failure, high and low temperature alarm and the controller in power-on state, the buzzer will sound and will become mute when pressing any key; after all the failures are recovered or 30 minutes later, the mute will fail.

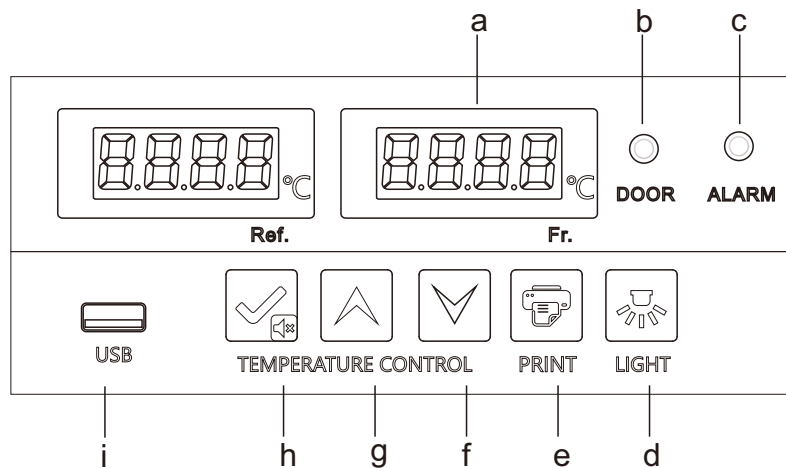

Type B control panel

(Applicable to YCD-FL289/YCD-EL300//YCD-EL450/YCD-FL450/YCD-FL519)

1. Function description of Type B control panel

- a. is temperature display window, which displays the average temperature inside the upper refrigerator chamber and lower freezer chamber of the cabinet body in °C under normal operation (the lower chamber temperature range of YCD-EL series is -10~-26°C); Different prompt characters can be displayed in the setting state (see below for details).
- b. Door opening indicator: When the refrigerator chamber door is opened, the indicator lights up. After more than 1 minute, the door opening alarm indicator light will be on and the buzzer triggered, displaying “door”.
- c. Fault indicator light: When the product runs normally, the indicator light is off; The indicator light is on for operation abnormality.
- d. “LIGHT:” after the equipment is powered on, the light is off by default, and the on-off of the light can be adjusted by the on-off key. When the light is out, it will be turned on by opening the door and then turned off by closing the door; When the light is on, it will keep on if you open or close the door. This equipment has two functions: automatic lighting and manual lighting. In the automatic lighting state, the lighting lamp will be on immediately when the door is opened, and the lighting lamp will be off after a 5 seconds delay; The user can also turn on the lighting lamp manually. In this case, the lighting lamp is always on (the indicator light above the key is on) without being controlled by the door opening and closing. Only when the manual lighting is turned off by pressing the light switch key again can the lighting lamp be automatically on (the indicator light above the key is off).
- e. “PRINT:” the system can keep 7 days of data for printing. Press the print key to print the temperature within the set time period.
- f. : In parameter setting mode, reduce the parameter value. For example, when adjust the set temperature, press this key reduce the set temperature. When adjust the parameter value, long press the down button, and the parameter will decrease rapidly.
- g. : In parameter setting mode, increase the parameter value. For example, when adjust the set temperature, press this button to increase the set temperature value. When setting the parameter value, long press the up button, and the parameter will increase rapidly. Under normal conditions, long press the up key for 3 seconds to import the data of the USB flash drive in 12 months.
- h. : is the set/mute key; in case of no alarm state and key unlocked state, press display the ambient temperature for 5s and then return to normal display; in the unlocked state, press for more than 3s, can enter the user menu. When buzzer is triggered (including cabinet including high temperature alarm, door opening alarm, sensor fault alarm, etc.) and in the button unlock state, press for the first time, and the buzzer stops ringing, and the ambient temperature is displayed for 5s, after which the normal display is resumed (pressing the mute button is only to turn off the buzzer for alarming this abnormal state, for example trouble removal, and the buzzer will be triggered next time for any abnormality). Then press again, trigger the buzzer, display the ambient temperature for 5s, and then resume the display of cabinet temperature and alarm state. In the key unlock state, can be used as a setting key.



In unlock state and parameter setting mode, press this key to display parameter values and parameter names. If the pressing time is longer than 3 seconds, save the settings and return to the normal interface.

I. USB interface

Automatic export: when the U disk is connected to the USB interface, the recorder buzzer will chirp once and display "on". PDF files of data that not currently exported will be generated in the U disk. After data transmission, the buzzer will chirp once again and display "End".After 6s, it will return to normal display.





! Note: When there is less data, "USB," "on" and "End" prompts are not displayed.







Manual export of USB data: In the key unlock state, when the USB flash drive is connected and the file is not being generated, press the up key for 3 seconds, and the digital tube in the lower chamber will display "d01." Press the key up or down key to adjust "d00~d12," and press  key to cancel the file generation (d00) or generate the PDF file of the record data of the previous months (1-12).

! Note: When the alarm of the digital tube flashes and displays "LoF," the recorder is not started; Meanwhile press  and  key for 3s, and "LoF" disappears, the recorder is started.

2. Function setting of Type B control panel

- 1). After powering on, the machine will enter into the working state;
- 2). User parameter settings:

Unlock: Under normal operation, press  and  key for 3 seconds at the same time, and the digital tube in the upper chamber will display "PS1" and the digital tube in the lower chamber will display the parameter code "0000". Press , enter the password "0005" (when entering the user menu password, enter "0099" to restore the key lock password to the default "0005."), and unlock it. Unlock and press  key for 3s, and the digital tube will display the parameter code "PS1" and enter the setting and adjustment parameters.

- ① Use  to scroll the parameters;
 - ② Use  or  to increase or decrease the value;
 - ③ Use  to temporarily store the modified values and return to the display parameters;
 - ④ If other parameters are modified, repeat steps ①~③.
 - ⑤ Press  for more than 3s, save the modified parameters and return to the display parameter category.
- 3). Press  for more than 3s, or press no key in 60S to exit the parameter setting program.

No.	Menu item	Parameter range	Suggested settings	Remarks
1	b1	--	—	Hardware version
2	b2	--	—	Software version
3	Set1	0.0~10.0	5.0	Refrigerator temperature setting

3. Parameter display

No.	Menu item	Parameter range	Suggested settings	Remarks
4	H01	0.0~10.0	5.0	Set value of high temperature alarm set+H; when H = 0, High temp alarm is disabled; When the alarm is over high temp alarm set, H01 will be displayed on the controller
5	L01	0.0~10.0	5.0	Set value of low temperature alarm set-L; when L = 0, low temp alarm is disabled; when the alarm is below low temp alarm set, L01 will be displayed on the controller
6	Set2	YCD-EL series: -10~-26 YCD-FL series: -10~-40	YCD-EL series: -20 YCD-FL series: -40	Freezer temperature setting
7	H02	0.0~10.0	5.0	Set value of high temperature alarm set+H; when H02 = 0, High temp alarm is disabled; When the alarm is over high temp alarm set, H02 will be displayed on the controller
8	L02	0.0~10.0	5.0	Set value of low temperature alarm set-L; when L02 = 0, low temp alarm is disabled; when the alarm is below low temp alarm set, L02 will be displayed on the controller
9	Pt	0~240 min	20	Print interval
10	tH1	20.0~50.0°C	40	Upper limit of ambient temperature alarm
11	P1	1. Automatic heating mode 1 2. Automatic heating mode 2 3. Automatic heating mode 3 4. Always on Always off	1. (Set to 4 when the door is with condensation)	Mode 1: It shall be judged as once after the door is opened and closed once and heated for 5min (time setting). If the door is opened and closed again during the heating period, the heating time will be updated again; Mode 2: After the compressor is running. Heater on; When the compressor stops, the heater is delayed for 1 minute for turn-off; Mode 3: When the humidity in the cabinet is more than 80%, the door heating is on, and when the humidity in the cabinet is moderately less than 60%, the door heating is off; Mode 4: Door heating is always on; Mode 5: Door heating is always off.
12	PS1	0000~9999	0005	User menu password settings
13	MAX	—	—	The highest temperature since last clearance
14	NIN	—	—	The lowest temperature since last clearance
15	CLR	—	—	Clearance of the Max and Min temperature records

Quick setting of time after power on

After the power-on self-test on the display board is completed, the quick setting menu is displayed.

Menu item	Menu	Menu description	Set range	Default	Unit
Quick Settings menu	n	Set logger module time - year	10~50		/
	y	Set logger module time - month	1~12	--	/
	r	Set logger module time - day	01~31	--	/
	S	Set logger module time - hour	00~23	--	/
	F	Set logger module time - minute	00~59	--	/
	Pt	Print interval	0~240	20	min
	SCY	Temperature data recording period	0~240 0: shielded recorder	10	min

If there is no operation for 60 seconds under the quick setting menu, it will automatically exit the quick setting menu and return to normal display.

4. Alarm display

Alarm Code	Default Description
H01	Upper refrigerator chamber high temperature alarm
L01	Upper refrigerator chamber low temperature alarm
H02	Lower freezer chamber high temperature alarm
L02	Lower freezer chamber low temperature alarm
H03	High ambient temperature alarm
door	Door opening alarm
PF	Power failure alarm
bL	Low battery alarm
Er	The recorder is not connected
LoF	The recorder is not started
EE	Communication failure

6.2 Optional function

1. Printer

The printer has been installed with a paper roll at the factory. If the paper roll is used up after a long period of use, you can buy the same paper roll (size: thermal paper, paper width: $57.5\pm 0.5\text{mm}$, the outer diameter of the reel: not greater than 40mm, i.e., RM57*40 back-roll paper)

Description of printer panel:

- ① Open button. Press to open the cover;
- ② SEL button, indicator light, for factory setting. Do not press it;
- ③ Lf button. The green indicator is the power indicator and it is normally on when the power is turned on;
- ④ Paper roll

Install the paper roll:

Press the open button 1, open the cover, install the paper roll, close the cover plate and allow the head of the roll paper to slightly extend out of the cover plate.

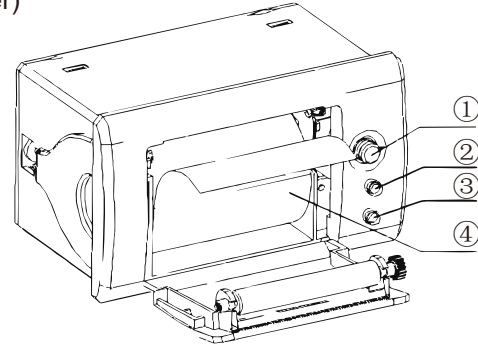

2. Remote alarm terminal, RS485 interface and network interface

Remote alarm terminal, RS485 interface and network interface are installed in the lower part of the back of the freezer body.

Note: These configurations are standard for some models.

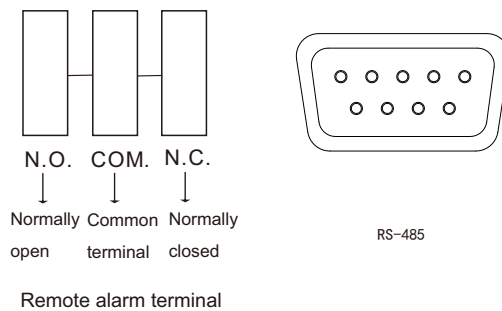

Model	Ambient temperature	Climate type	Refrigerant and loading amount	(Rated) voltage (V~)	Rated frequency (Hz)	Temp Range (°C)	Volume (L)	(Rated) current (A)	Net Weight (kg)	Exterior Dimensions (DxWxH) (mm)
YCD-EL300 (Spraying aluminum liner)	16~32°C	N	Refrigerant:R600a/20g Freezer:R600a/60g	220-240	50	Refrigerant:2~8°C Freezer:-10~-26°C	300	1.37	95	640×700×1876
YCD-EL300 (HIPS)	16~32°C	N	Refrigerant:R600a/20g Freezer:R600a/60g	220-240	50	Refrigerant:2~8°C Freezer:-10~-26°C	300	1.37	87	640×700×1842
YCD-EL300 (Stainless steel liner)	16~32°C	N	Refrigerant:R600a/20g Freezer:R600a/60g	220-240	50	Refrigerant:2~8°C Freezer:-10~-26°C	300	1.37	104	640×700×1876
YCD-EL450 (Spraying aluminum liner)	16~32°C	N	Refrigerant:R600a/26g Freezer:R600a/75g	220-240	50	Refrigerant:2~8°C Freezer:-10~-26°C	450	2.10	144	735×810×1960
YCD-EL450 (HIPS)	16~32°C	N	Refrigerant:R600a/26g Freezer:R600a/75g	220-240	50	Refrigerant:2~8°C Freezer:-10~-26°C	450	2.10	127	735×810×1960
YCD-EL450 (Stainless steel liner)	16~32°C	N	Refrigerant:R600a/26g Freezer:R600a/75g	220-240	50	Refrigerant:2~8°C Freezer:-10~-26°C	450	2.10	162	735×810×1960
YCD-FL289 (Stainless steel liner)	16~32°C	N	Refrigerant:R600a/20g Freezer:R290/45g	220-240	50	Refrigerant:2~8°C Freezer:-10~-40°C	289	2.5	143	640×700×1845
YCD-FL450 (Spraying aluminum liner)	16~32°C	N	Refrigerant:R600a/30g Freezer:R290/42g	220-240	50	Refrigerant:2~8°C Freezer:-10~-40°C	450	3.12	146	735×810×1960
YCD-FL450 (HIPS)	16~32°C	N	Refrigerant:R600a/30g Freezer:R290/42g	220-240	50	Refrigerant:2~8°C Freezer:-10~-40°C	450	3.12	125	735×810×1960
YCD-FL450 (Stainless steel liner)	16~32°C	N	Refrigerant:R600a/30g Freezer:R290/42g	220-240	50	Refrigerant:2~8°C Freezer:-10~-40°C	450	3.12	164	735×810×1960
YCD-FL519 (Stainless steel liner)	16~32°C	N	Refrigerant:R600a/26g Freezer:R290a/65g	220-240	50	Refrigerant:2~8°C Freezer:-10~-40°C	519	3.57	186	740×910×1972

* The foaming agent of this product is cyclopentane.

10. Accessories

Name	Operation Manual	Qualified Certificate	Key	Defrosting shovel
Number	1	1	2	1

YCD-FL289,YCD-FL519 do not have keys.

* The specific accessories shall be subject to the physical objects received.



 **Order here!**

Zhongke Meiling Cryogenics Company Limited
Address: No 1862 Zishi Road, Hefei City, Anhui, P.R. China
Production Address: No.1862 Zishi Road, Economic and
Technological Development Zone, Hefei City
Post Code: 230601
Material Code: 890375566
Email: zkmeiling@zkmeiling.com; technical.service@zkmeiling.com
Website: www.melingbiomedical.com
Production Date: See nameplate on the freezer body
Prepared in: August 2023