

User Guide

ARE H9 Full-ISO Pocket Reader



1	INTRODUCTION	4
2	ELEMENTS OF THE ARE H9	5
3	OPERATION GUIDE	6
3.1	Installation of the battery	6
3.2	Power on / off	6
3.3	Reading a transponder in standard mode	7
3.4	Reading Range	8
4	DATABASE	9
5	MENU FUNCTIONS	9
5.1	Navigating the trough the menu function	9
5.2	Overview of the menu functions	10
5.3	Set Attribute	11
5.4	Operating mode	12
5.4.1	Standard mode	12
5.4.2	Online/USB ^{**)} or Online/BT ^{*)} mode	12
5.4.3	Online/USB H or Online/BT H ^{*)} mode – handshake mode	14
5.4.4	Database/USB or Database/BT ^{*)} mode.	15
5.5	Set Interface /Bluetooth Selection (only with optional Bluetooth-module)	16
5.5.1	Interface USB ^{**)}	16
5.5.2	Set Interface to Bluetooth Slave	17
5.5.3	Set Interface to Bluetooth Master	18
5.5.4	Bluetooth Disconnect	20
5.6	Lock Up Reader	20
5.7	Set Code Format	21
5.8	Erase Memory	22
5.9	Reading time	23
5.10	Turn-off time	23

5.11	Turn-on delay	24
5.12	Keyboard Sound	24
5.13	Set Time (available only with Real-Time-Clock module expansion)	25
5.14	Set Date (available only with Real-Time-Clock module expansion)	26
5.15	Language/Sprache – select display language	27
5.16	Reader-Version	27
6	USB DRIVER INSTALLATION *) (**)	27
6.1	Virtual RS232 Com Port	30
6.2	COM Port Setup with Windows Device Manager	30
7	USB INTERFACE CONFIGURATION USED IN ONLINE AND DATABASE MODE	33
8	RS232 INTERFACE SETTINGS (**)	33
9	CONTROL CHARACTERS USED IN THE ONLINE MODE	33
10	TECHNICAL SPECIFICATIONS	34
11	OPERATION WITH OTHER RF ID EQUIPMENT	34
12	SAFETY INSTRUCTION	35
13	FCC INFORMATION	35
14	NOTIFICATION OF CHANGES	36
15	CONTACTS	36

1 Introduction

The ARE H9 is a RFID Pocket Reader designed to read passive Read-Only-Transponder. It has the ability to store the Transponder-Codes in its internal database.

This Pocket Reader is equipped with a USB Interface ^{**)}, which allows transmitting single transponder codes or its entire database to a computer.

It is especially suitable for animal identification, logistics and asset tracking

The ARE H9 Full-ISO is capable to read the following transponder types:

- FDX-B Read-Only(according to ISO 11784/11785)
- HDX-B Read-Only(according to ISO 11784/11785)
- Trovan
- PSK1
- ASK64bit

The ARE H9 does not synchronize with other RFID readers operating in close vicinity.

Before the initial use of this ARE H9 reader please study this manual carefully.

^{**)} RS232 Interface in Rs232 version

2 Elements of the ARE H9



***) RS232 cable in Rs232 version

3 Operation Guide

3.1 Installation of the battery

Slide door of the battery compartment to open it.

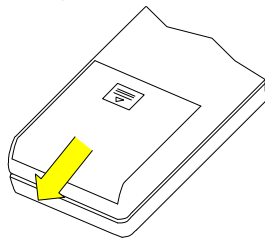

Attach the Battery to the connector inside. Put the Battery into the compartment.

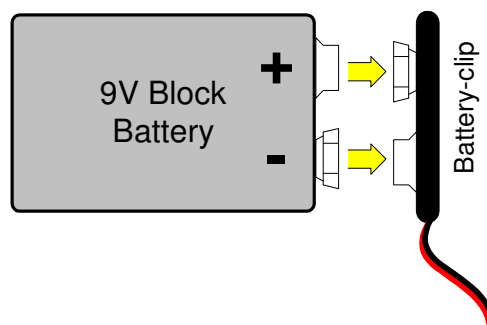

Slide the door back to close it. Use only 9V E-Block alkaline Batteries of the Type 6LR61.

3.2 Power on / off

The Pocket Reader is switched on by pressing the main button for 0,5s (default). The reader starts in reading mode.

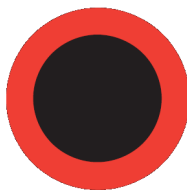

The ARE H9 will switch off automatically after 20s (default) when no button has been pressed within this time.

3.3 Reading a transponder in standard mode

Press the main button to start the reading process.



The ARE H9 starts the reading process and the display shows:

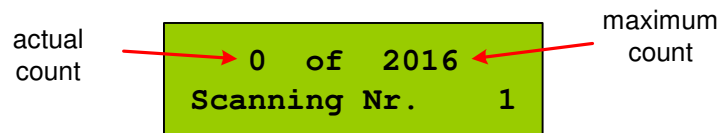

Approach a transponder within the readers reading range.

The reader emits a beep when the transponder has been read successfully, and the transponder code is shown on the display:

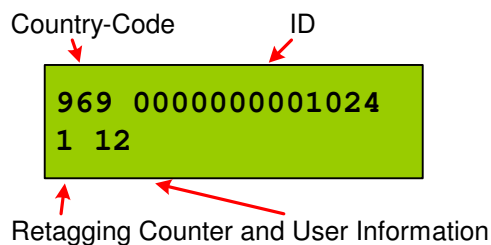

For ISO Transponder additional the retagging counter and the user information field are displayed in the second row of the display.

In case no transponder has been read within the given time frame, the reader stops its reading process and the display shows:

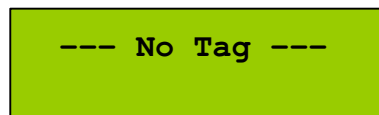

For further reading processes release the main button and press it again for each attempt.

3.4 Reading Range

The reading range and distance depends on the transponder, its packaging and orientation to the reader. The following diagram shows the typical area where a glass transponder should be read:

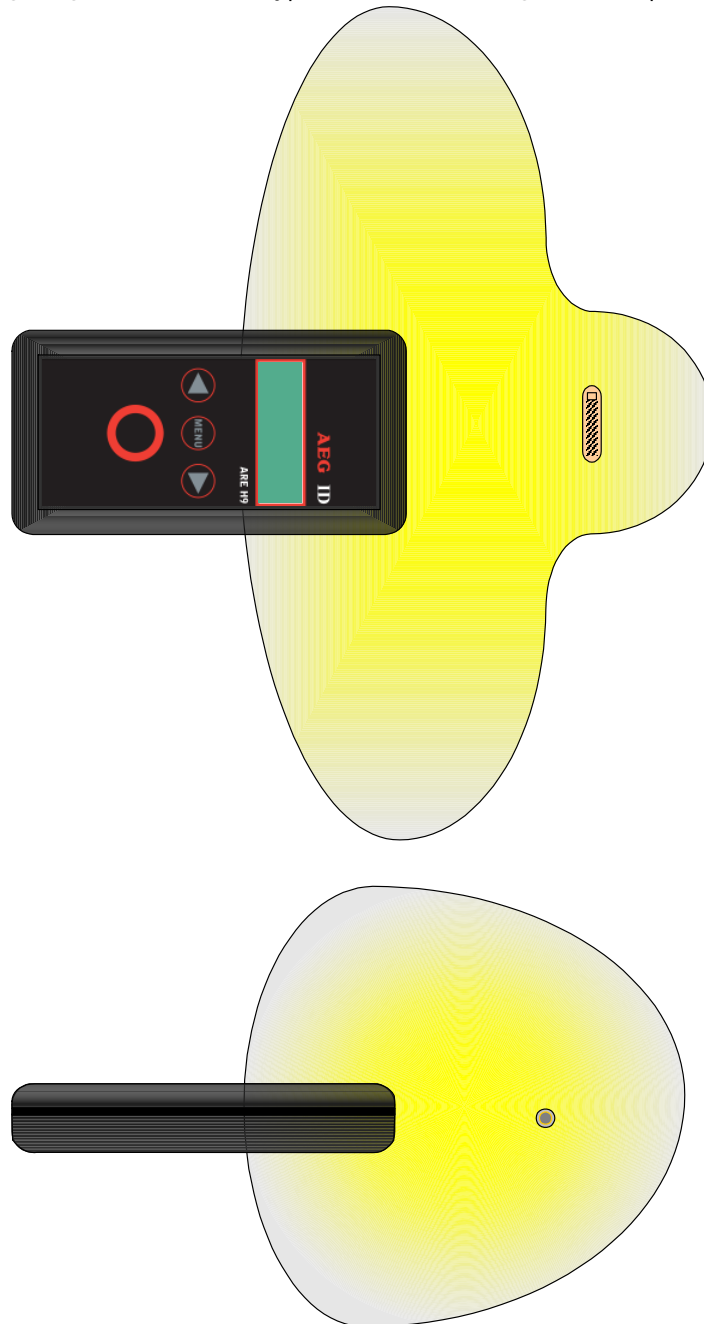

The ARE H 9 is not capable to read two or more transponders which are at the same time in the antenna field.

4 Database

When a reading had been accomplished successfully, in the standard operating mode, the ARE H9 internal database will be checked whether this transponder code is already stored.

If the new code, in combination with the attribute, is not found in the database, it will be stored as a new record. This record is composed of the ID-code, the transponder type, the selected attribute. With the optional real time clock module date and time of reading will be also stored.

If the new code is already stored in the database, it will be not stored again. In this case the reader emits 2 successive beeps.

The database is capable to store up to 2016 transponder codes. When the maximum of the storage is reached no further new code is stored. To store new codes in this case the database has to be erased.

The database of the ARE H9 with all its actual records could be transmitted to a PC; also it is possible to receive a new database from a PC. This is done in the Database/USB mode described in chapter 5.4.4. On Power Loss the ARE H9 will keep its database data.

5 Menu Functions

5.1 Navigating the trough the menu function



By pressing the menu button it can be chosen between the different menu function. If the menu button is pressed again the ARE H9 cyclic changes to the next menu function.



Inside a menu function the setting for the function could be changed with the arrow buttons.

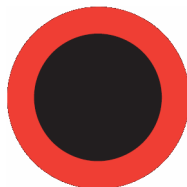

With the main button the actual menu function setting is selected and the ARE H9 changes back to the transponder reading mode.

5.2 Overview of the menu functions

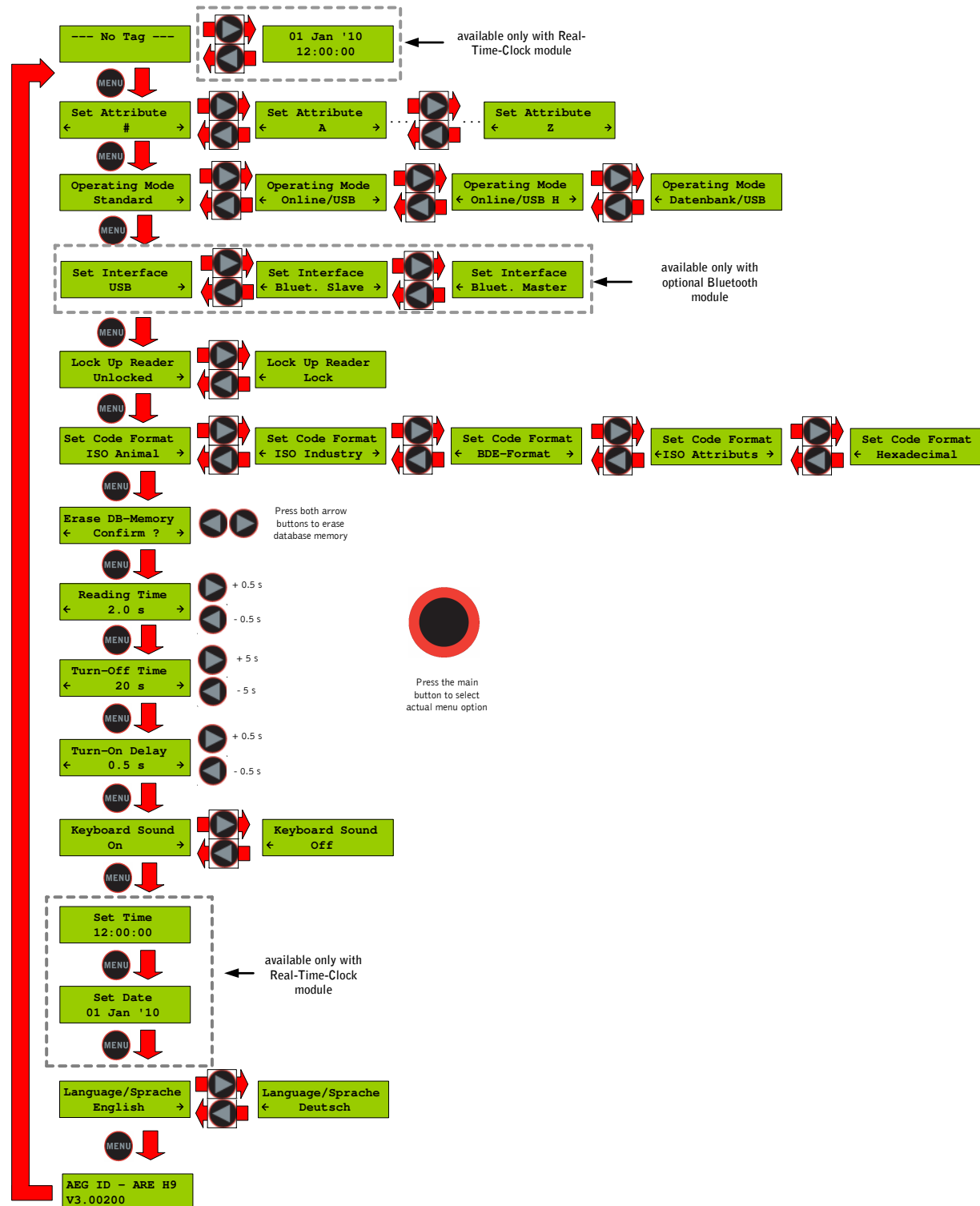

5.3 Set Attribute

With set attribute one of 27 attributes could be selected for the next read transponder.

The selection is done by the left/right arrow buttons and confirmed by pressing the main button.

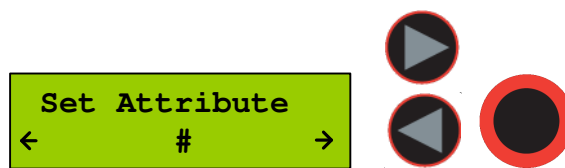

In standard read mode this selected attribute will be stored together with the transponder ID-code of the next read transponder in the internal database of the ARE H9. When the Code Format is set to Attributes will the selected attribute or its text displayed in the rightmost corner of the second display line.

Example of Transponder-ID with no attribute:

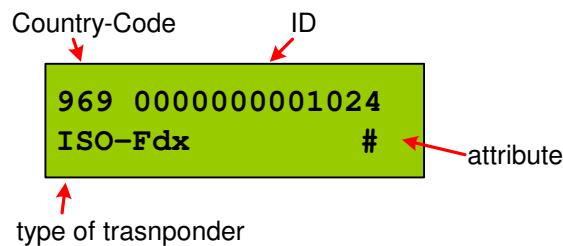

In the initial configuration all the 27 attributes available have a standard text assignment.

#, A, B, C, D, E, F, G, H, I, J, K, L, M, N, O, P, Q, R, S, T, U, V, W, X, Y, Z

With a PC-software and using the Database/PC mode of the ARE H9 it is possible to assign each attribute a custom text with up to 14 ASCII characters.

Example:

A becomes "stable",

B becomes "pasture"

C becomes "vaccination"

Under Set Attribute at the ARE H9 it is now possible to select the attribute by this custom text.

When a transponder has been read with a attribute set up with a custom text, the text assigned to the attribute will now be shown on the lower line of the display, right justified, instead of the attribute.

Example of Transponder-ID with attribute and assigned text "Stall":

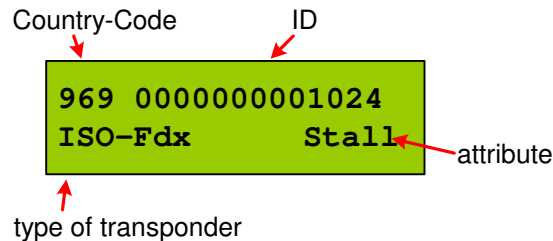

5.4 Operating mode

The menu "Operating Mode" switches between the following modes: Standard, Online/USB mode and Database/USB mode.

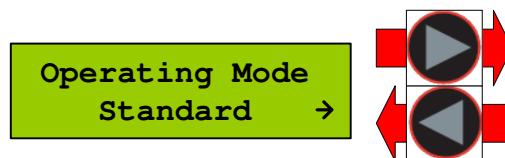

5.4.1 Standard mode

In the standard mode will the read transponder codes stored into the internal database of the ARE H9. For a detailed description see section 3.3 and 4.

5.4.2 Online/USB ^{**)} or Online/BT ^{*)} mode

In the online mode the transponder codes will not be stored into the internal database of the ARE H9. The transponder codes are immediately transmitted via the USB interface to an attached PC, PDA, etc.

It is important that there is a USB ^{**)} or Bluetooth ^{*)} connection established to a host-device ready to receive the data; otherwise the read transponder codes are lost because they are not stored in this mode.

The reading process is the same as in standard mode; the second display-line shows the information of the selected "online/USB" ^{**)} or "online/BT" mode in between the reading processes.

^{*)}only with optional Bluetooth module
^{**)} Ser. for Rs232 version

The data format used in online mode to transmit the transponder codes is as follows:

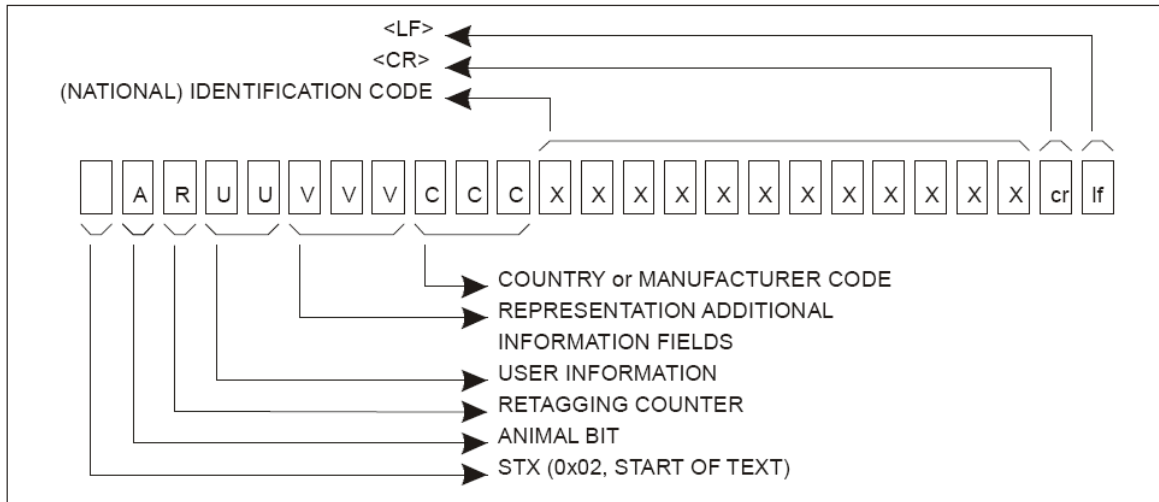

Example:

ASCII	STX	A	1	1	2	0	0	0	9	6	9	0	0	0	0	0	0	0	1	0	2	0	CR	LF
Hexadecimal	02	31	31	31	32	30	30	30	39	36	39	30	30	30	30	30	30	30	31	30	32	30	0D	0A

The transponder code is transmitted as ASCII string the transmission is completed by the control characters <CR> <LF>.

The online mode could be terminated by choosing another mode selection within the operation mode menu.

Once the online mode is active, the ARE H9 will be automatically in the online mode when it switched on again after switched off.

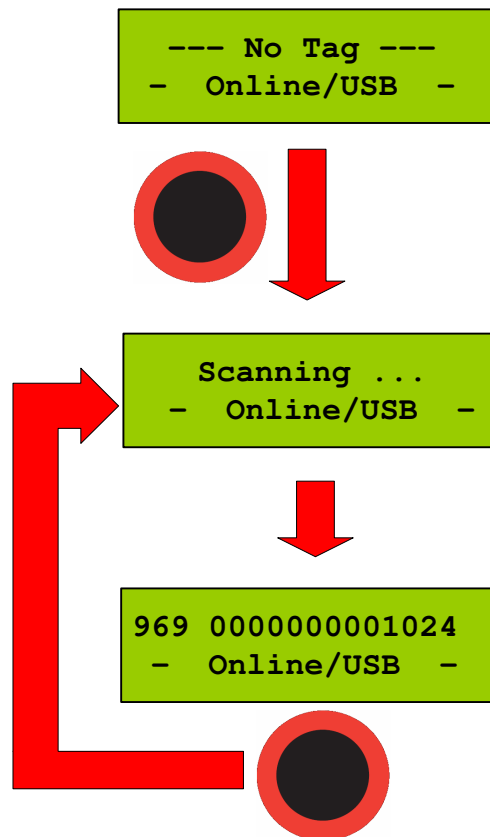

To leave the mode "Online/USB" under "Operating Mode" another mode has to be selected

5.4.3 Online/USB H or Online/BT H^{*)} mode – handshake mode

The "online/USB H" or "online/BT H" mode has a similar to the "online/USB" with the difference that a read transponder code will not be sent immediately to the host (PC, PDA, etc.).

First the reader checks if a connection to the host is established before it sends the transponder code.

^{*)}only with optional Bluetooth module
^{**)}online/ser. for Rs232 version

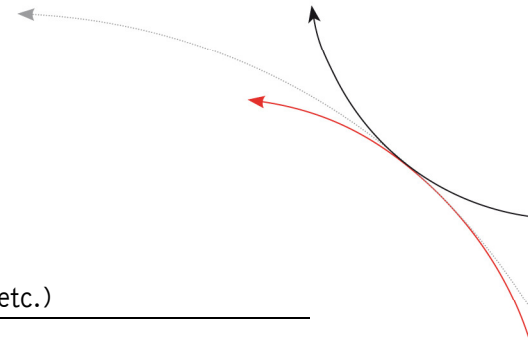

For this transmission the following protocol is used:

ARE H9	Host (PC, PDA, etc.)
<STX> <ETX>	->
<STX> < transponder data > <ETX>	<- <STX> <ACK> <ETX>
	->
	<- <STX> <ACK> <ETX>

If transponder ID was read the following is displayed:

```
999 000000000000
transmitting...
```

Does the host not answering to the <STX> <ETX> protocol of the ARE H9, then the ARE H9 will cyclic transmitting the <STX> <ETX> protocol until an answer of the host would be received. During this the following display appears:

```
Await Connection
< Abort ? >
```

The user can cancel this waiting for a response of the host by pressing both arrow buttons, but in this case the transponder ID will not transmitted.

5.4.4 Database/USB or Database/BT^{*)} mode.

In the database mode it is not able to read a transponder. It is intended to transmit and receive record sets of the ARE H9 internal database to a host device as a PC, PDA, etc.

To exchange data in the database mode a software called reader-terminal included with the ARE H9.

The usage of this software and the communication protocol is explained in an extra document included with the software.

The database mode could be terminated by pressing both arrow buttons simultaneously, or by initiating it by the PC-communication

```
Communic. Active
< Abort ? >
```



During the Database/PC mode the ARE h9 will not switch off automatically.

^{*)}only with optional Bluetooth module
^{**)} database/ser. for Rs232 version

5.5 Set Interface /Bluetooth Selection (only with optional Bluetooth-module)

This menu option is enabled with an installed Bluetooth module to switch between USB and Bluetooth and to choose the Bluetooth connection method:

- USB
- Bluetooth Slave
- Bluetooth Master

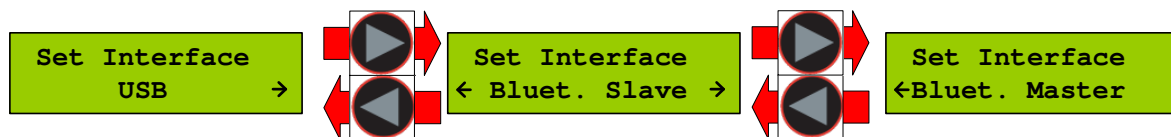

The ARE H9 supports only Bluetooth connection with the serial Port profile.

5.5.1 Interface USB **)

USB is the default configuration of the ARE H9. With this option enabled the complete communication to and from the ARE H9 is done by the USB cable connection. Choosing USB as interface automatically disables the any active Bluetooth connection,

**) serial for Rs232 version

5.5.2 Set Interface to Bluetooth Slave

This menu option configures the ARE H9 as Bluetooth slave. With the ARE H9 as Bluetooth Slave the Bluetooth-connection is established up by the Bluetooth-partner which is configured as master.

The ARE H9 checks after the selection of this option if there is an active Bluetooth connection, in this case this connection will be closed.

Then the ARE H9 is waiting until a Bluetooth connection is established or the user cancels the operation by pressing both arrow buttons. During this operation the ARE H9 will not switch off automatically.

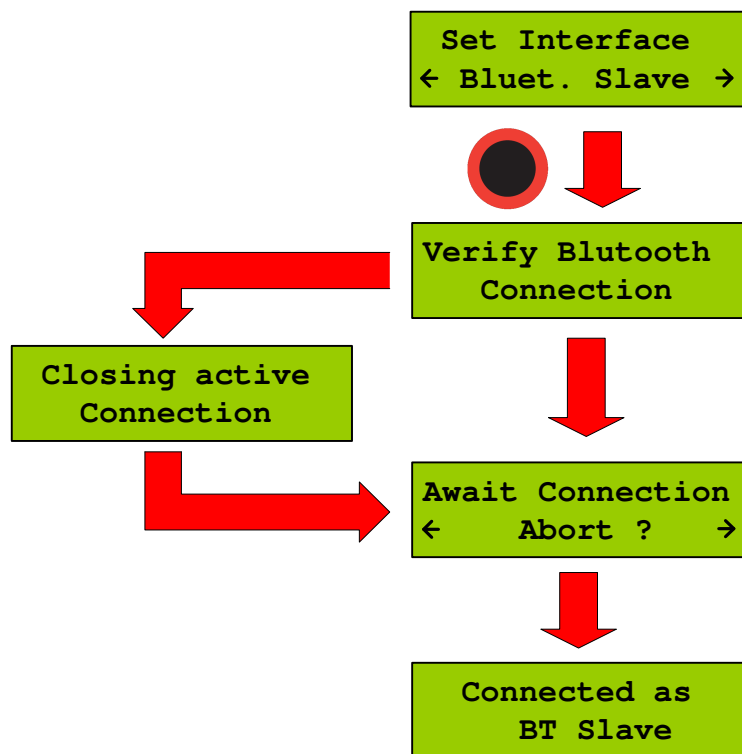

5.5.3 Set Interface to Bluetooth Master

This menu option configures the ARE H9 as Bluetooth master. In this configuration an Bluetooth connection with an partner is established by the ARE H9. In case there is still an active Bluetooth connection, this connection will be closed before a new one is established.

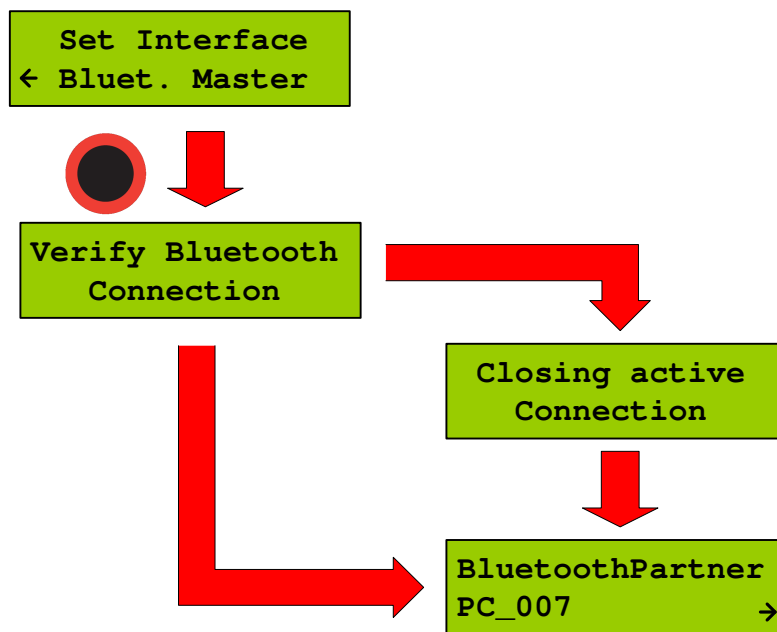

Was there a Bluetooth partner for the master connection configured before, this partner will be displayed as default option in the following dialog.

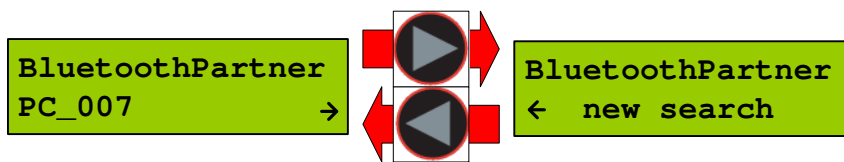

By pressing the arrow keys it is possible to switch the selection between the default partner and a new partner search.

By choosing the default partner, the ARE H9 will try to establish a connection. During this process the message "Await Connection" could appear, this is the case when the partner is not ready or at the partner side additional activities are necessary.

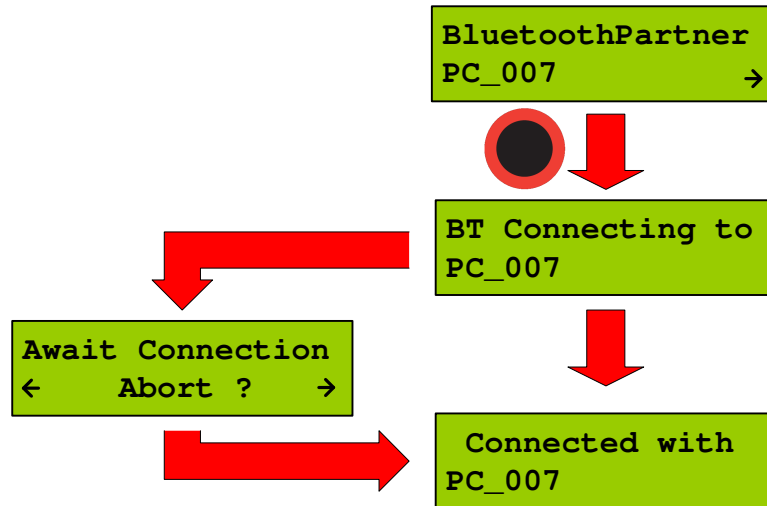

"new Search" starts a search process for Bluetooth devices in range of the ARE H9. The Bluetooth device search could last some seconds.

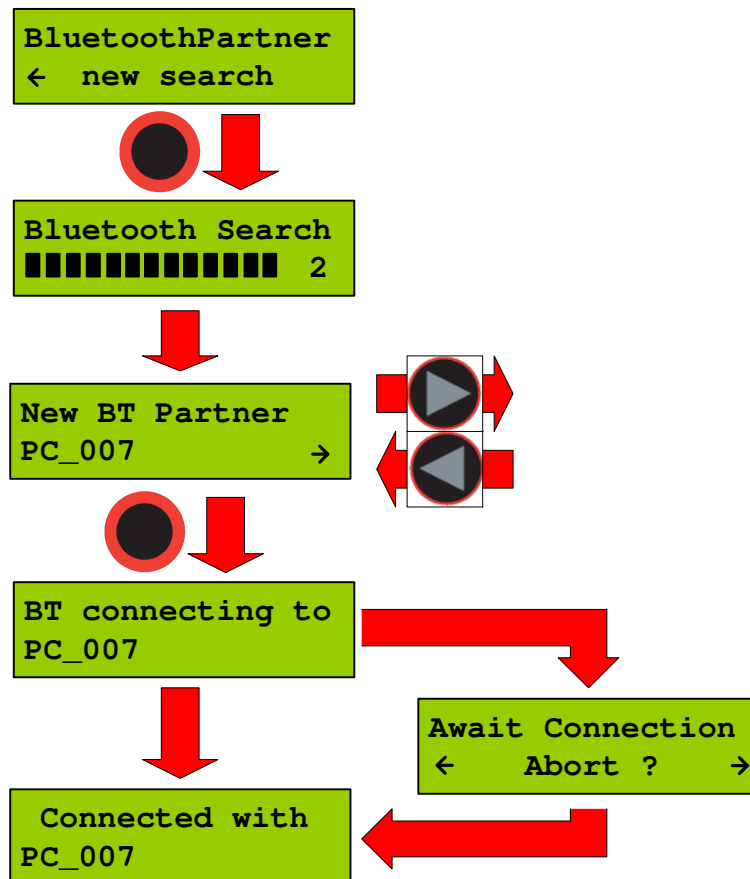

Was the search successful a selection of possible partners will be shown. The Bluetooth partner search can't detect if a Bluetooth device supports the serial port profile, the user has to know this. Was the search not successful the ARE H9 switches back to the "Set Interface" menu.

After choosing a partner from the found devices, the ARE H9 will try to establish a connection. During this process the message "Await Connection" could appear, this is the case when the partner is not ready or at the partner side additional activities are necessary.

A successful connection will be shown as follows:



**Connected with
PC_007**

5.5.4 Bluetooth Disconnect

Is the connection to the Bluetooth partner lost during the operating of the ARE H9, or maximum Bluetooth distance has exceeded, the following display appears:

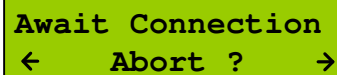

Await Connection
← **Abort ?** →

In this case will the ARE H9 wait as long as the connection is established again or the user cancels this screen by pressing both arrow buttons.

While switching off the ARE H9 the Bluetooth connection to a partner will automatically disconnect.

5.6 Lock Up Reader

When lock up reader is activated the ARE H9 switches off immediately. After switching on the pocked reader again it shows that it is locked.

During the ARE H9 is locked neither a reading process could started nor the menu could be accessed.

While it is not unlocked, it will switch off again after 5 (default) seconds no button is pressed. To leave this mode press both arrow buttons simultaneously.

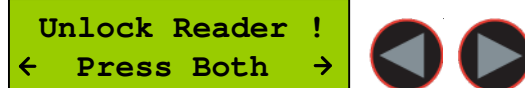

Unlock Reader !
← **Press Both** →



5.7 Set Code Format

This menu option sets the format of representation of ISO-code. The ARE H9 currently supports three code formats.

ISO Animal code format	for	ISO-FDX and ISO-HDX
ISO Industry code format	for	ISO-FDX and ISO-HDX
ISO BDE code format	for	ISO-FDX for waste management
ISO Attributes	for	ISO-FDX and ISO-HDX with attribute display (Like the former H5 display)
Hexadecimal	for	Trovan, PSK1, ASK 64bit, ISO-FDX and ISO-HDX

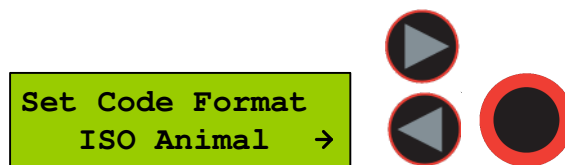

The selection sets the way in which the transponder code is displayed. This option has no influence to the reading function; it only filters how the read ID-code is displayed. This setting has only impact to ISO-FDX and ISO HDX transponders. For example, if code format is set to "ISO-Animal" and an ISO transponder without animal bit is read the ARE H9 will signal this with 3 beeps and the following display:

No ISO Animal
ISO-Fdx

The ARE H9 selects automatically the hexadecimal display if a Trovan, PSK1 or Ask64Bit transponder is read.

This setting is stored in the device and is still valid after power off/on operation.

5.8 Erase Memory

This function allows deleting all records in the internal database of the ARE H9. For safety reasons this function is activated only when both arrow buttons are pressed simultaneously.

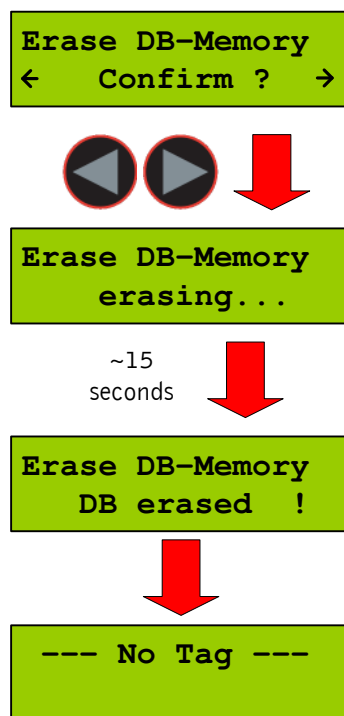

The erasing of the database memory can take several seconds.

! Do not disconnect the ARE H9 from the power supply during this erase operation; this could lead to damaging the database function of the reader.

After the erase operation has finished the device will return to the standard operating mode.

5.9 Reading time

This sets the time frame for one reading attempt. The time could be changed with the arrow buttons in 0,5s steps. A new time is set by pressing the main button.

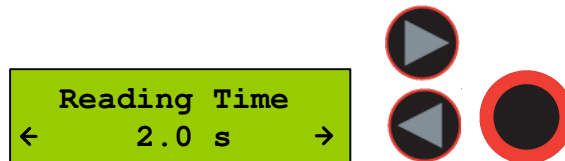

Default value	4 s
min. value	0,5 s
max. value	12,5 s

This setting is stored in the device and is still valid after power off/on operation. For optimal reading performance this setting is recommended to be between 2-4 seconds.

5.10 Turn-off time

Sets the time until the ARE H9 will automatically shut off while no button is pressed or activity lasts. It could be change with the arrow buttons in 5s steps.

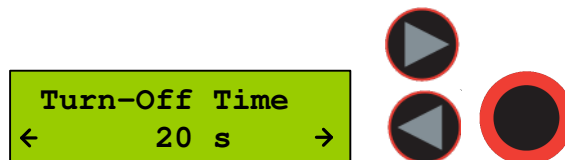

A new time is set by pressing the main button.

Default value	20 s
min. value	10 s
max. value	300 s

This setting is stored in the device and is still valid after power off/on operation.

5.11 Turn-on delay

Sets the time the main button is to be pressed to switch on the ARE H9. The time could be changed with the arrow keys in 0,5s steps.

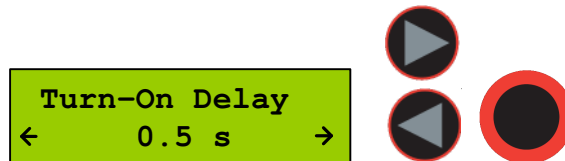

A new time is set by pressing the main button.

Default value	0,5 s
min. value	0 s
max. value	5 s

This setting is stored in the device and is still valid after power off/on operation.

5.12 Keyboard Sound

Here the beep sound of the keyboard could turn on or off.

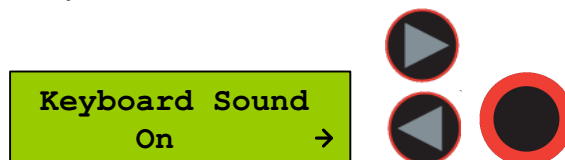

This setting is stored in the device and is still valid after power off/on operation.

5.13 Set Time (available only with Real-Time-Clock module expansion)

This menu option sets the time of the optional Real-Time-Clock module expansion. With this expansion module it is possible to add a time and date code, of reading, to the transponder ID in the database. The Real-Time Clock module is equipped with a own backup-battery to hold the time and date even if the ARE H9 is switched off or the main battery of the ARE H9 has to be changed.

To set the time press select this option with the main button, now is it possible to change the hours with the left/right arrow button. The hour setting is accepted by pressing the main button; the ARE H9 switches now the minute setting. The minute and second setting is working in the same way as the hour setting. After setting the second the Real-Time-Clock will be synchronized with this new time. To abort the processes during Set Time press the menu button.

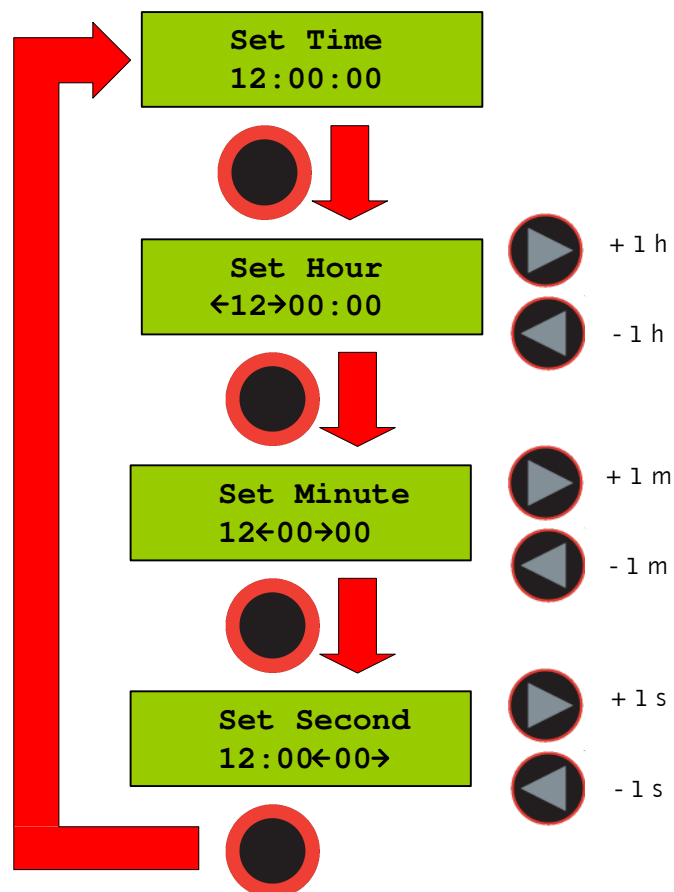

5.14 Set Date (available only with Real-Time-Clock module expansion)

This menu option sets the date of the optional Real-Time-Clock module expansion. To set the date press select this option with the main button, now is it possible to change the day of month with the left/right arrow button. The day setting is accepted by pressing the main button; the ARE H9 switches now the month setting. The month and year setting is working in the same way as the day setting. After setting the second the Real-Time-Clock will be synchronized with this new date. To abort the processes during Set Date press the menu button.

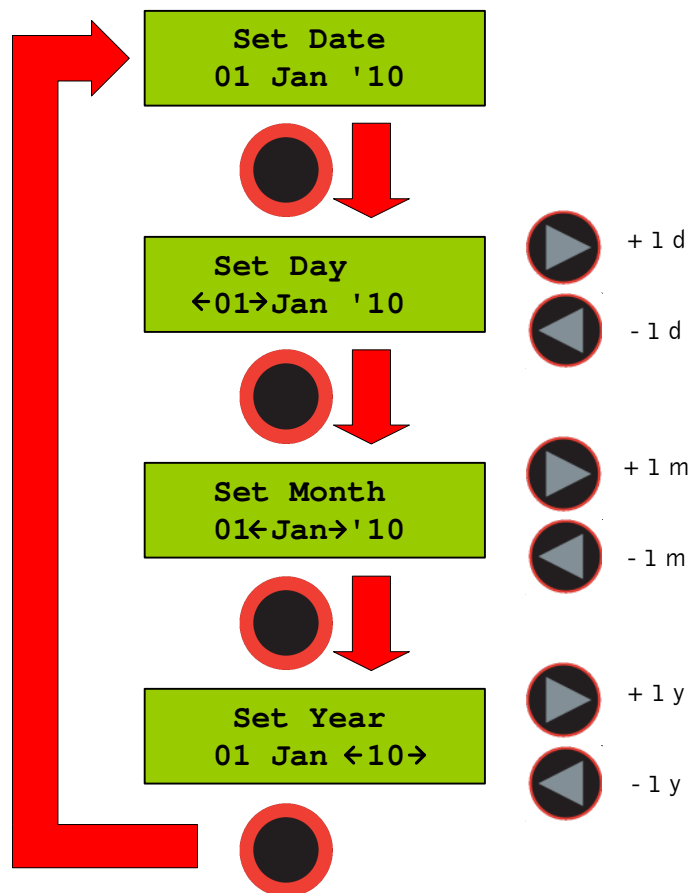

5.15 Language/Sprache – select display language

With this menu option is it possible to change the language of the ARE H9 menu-display.

Language/Sprache
English →

5.16 Reader-Version

This menu option shows the Firmware Revision of the ARE H9.

AEG ID – ARE H9
V3.00136

6 USB driver installation ^{*)}***)

To use the online and the database mode the ARE H9 is connected via USB to a host PC. Before the USB connection could be used a USB to RS232 bridge drive has to be installed.

Insert the driver disc supplied with the ARE H9 into your CD-Rom or DVD-Drive of the host PC you want to use with the pocket reader. Connect the ARE H9 with the supplied USB cable to a free USB port of your PC (USB1.1 and USB2.0 ports are supported).

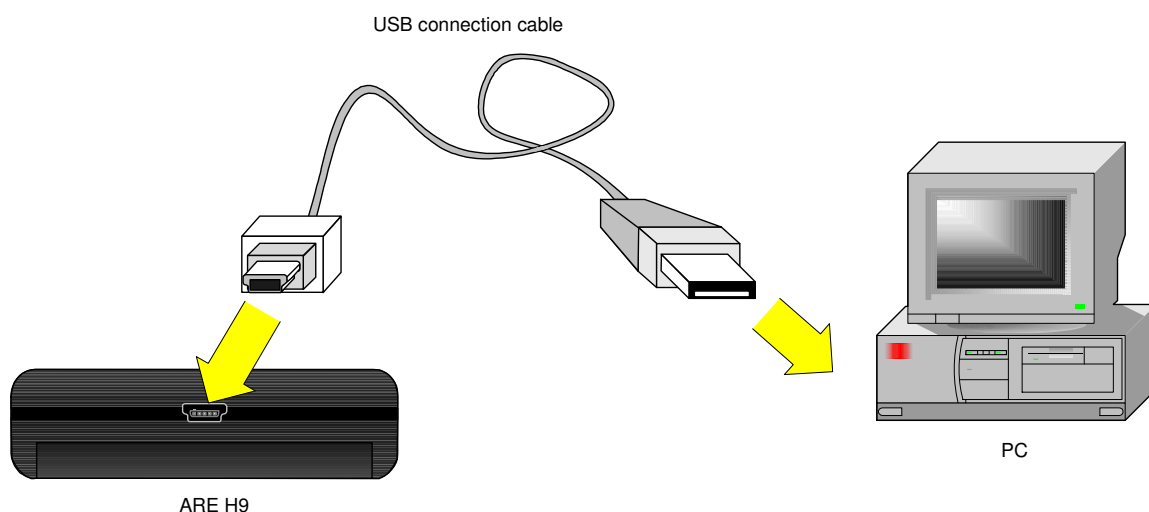

^{*)} not for Rs232 version

***) forHID Version driver installation is described in the extra documenation

USB Device Driver

The PC will detect a new hardware; Windows opens the Found New Hardware Wizard.



If the Found New Hardware Wizard asks to connect to Windows Update, select „**No, not this time**“, then click „**Next**“.

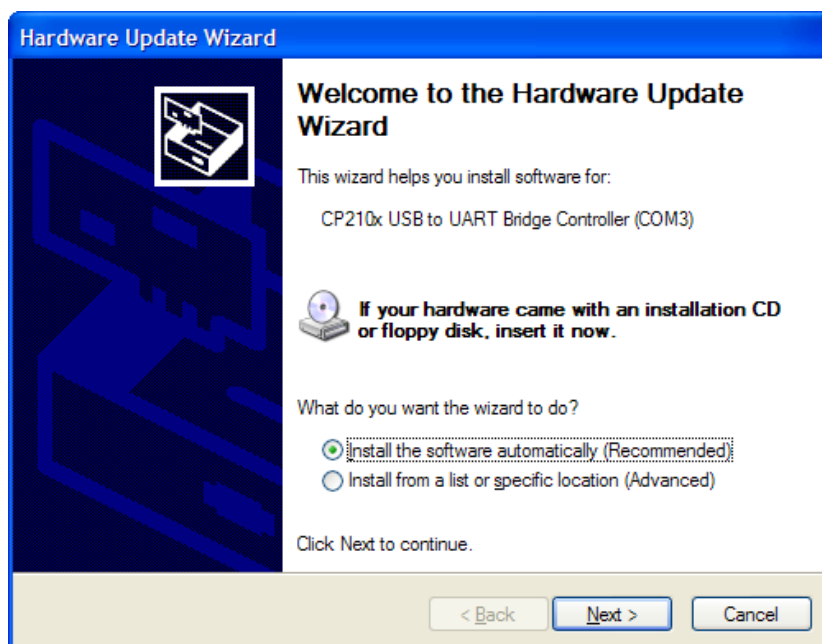

In the next windows of the Hardware Update Wizard select „ **Install from a list or specific location (Advanced)**“.

In the search dialog choose „ **Search for best driver in these locations**“. Specify the CP210x driver located in the CD folder „..USB_RS232_bridge_driver“.

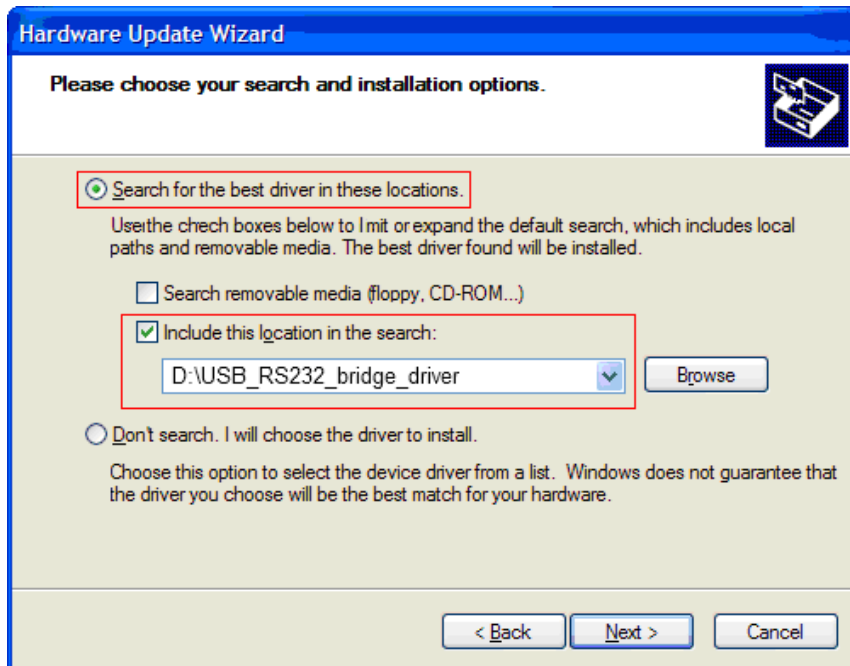

Click „ **Next**“ after setting the path to the driver location

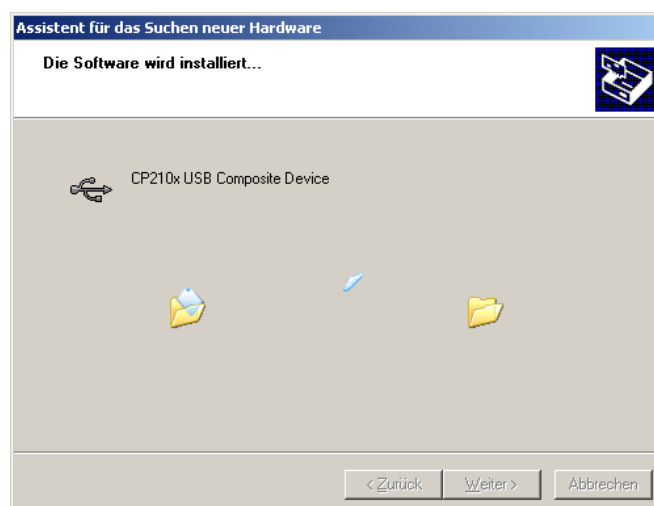

This completes the installation of the USB Device Driver.

6.1 Virtual RS232 Com Port

After installing the USB Device Drive Windows automatically starts the installation of the virtual RS232 Com Port.

Do this installation with the Windows **New Hardware Wizard** in the same way as with the USB Device Driver.

6.2 COM Port Setup with Windows Device Manager

After the installation of the USB Device Driver the COM port setting could be set and verified by the Windows Device Manager.

Open the Device Manager using start button -> select Run, type in the text field „**devmgmt.msc**“ and click „**OK**“.



Another method is to access the Windows Device Manager is: Start -> Control Panel -> System -> Hardware -> Device Manager.

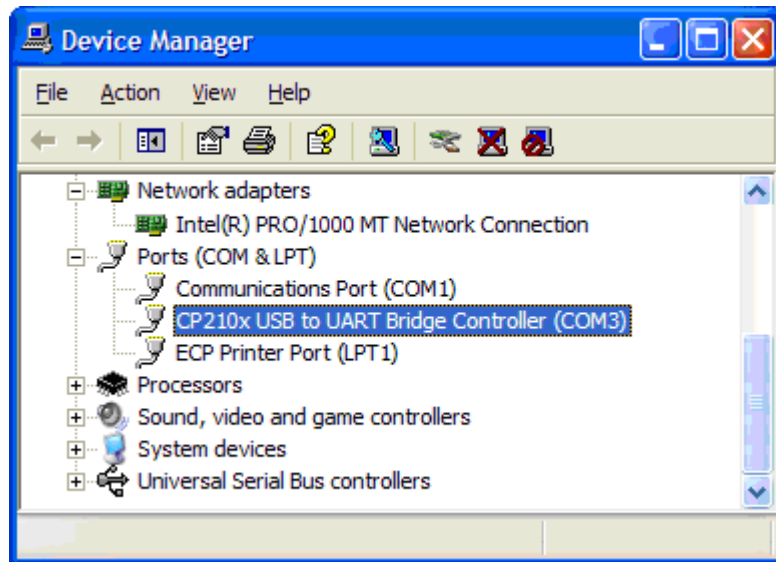

The COM driver for the ARE H9 is located under Port (COM & LPT):

„CP2101 USB to UART Bridge Controller (COMx)“

COMx stands for the COM port selected by the driver, this COM port could be used in the software to communicate with the ARE H9.

In case there is a COM port conflict or another port number is needed, the COM port number has to be changed.

To change the COM port, double click on „**Ports (COM & LPT) - CP210x USB to UART Bridge Controller**“. The Properties dialog will open.

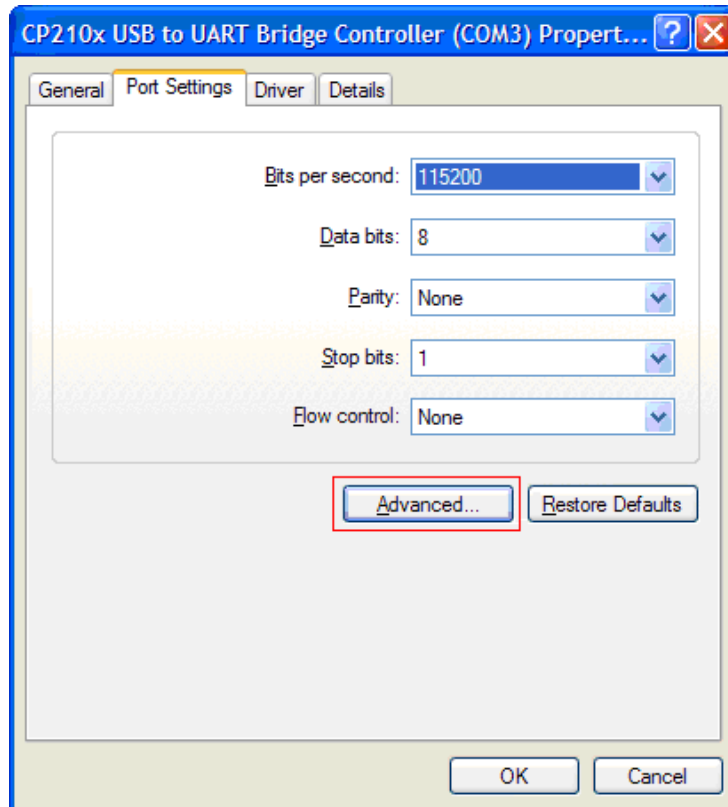

Select the „**Port Settings**“ tab and click on the „**Advanced**“ button.

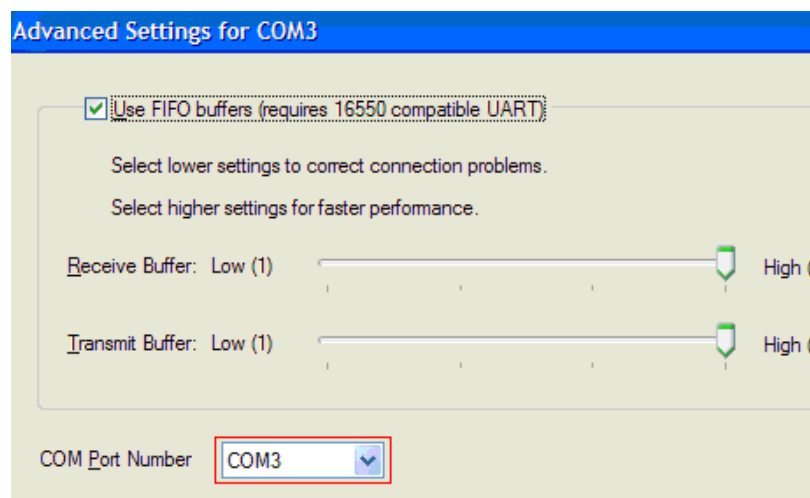

Select under „**COM Port Number**“ the port number to use, then click „**OK**“.

7 USB Interface Configuration used in online and database mode

The USB connection to the ARE H9 is established as an additional com port via a USB bridge driver on the host PC. The protocol uses the RS232 specification with the settings:

19200 Baud, 8 Data bits, no parity bit, one stop bit, no hardware handshake.

8 RS232 Interface Settings **)

If the ARE H9 Rs232 is used on a PC a Rs232-Crossover (lines Rxd, Txd are crossed) is necessary.

In Operation Mode "Database/Ser." and "online" are the following communication settings in use:

9600 Baud, 8 Data bits, no parity bit, one stop bit, no hardware handshake.

9 Control Characters used in the online mode

character	value hexadecimal	Function
<NL>	0x00	zero character, terminates text element
<STX>	0x02	start of text
<CR>	0x0D	carriage return
<LF>	0x0A	line feed

**) only in Rs232 version

10 Technical Specifications

electrical characteristic	
reading system	ISO FDX-B, ISO-HDX, Trovan, PSK1, ASK64Bit
operational frequency	134,2 kHz
display	LCD: 2-line by 16 charcaters
interface	USB
user memory	2016 Codes with attribute, type, text, with optional real time clock date and time
software	AEG ID Terminal PC-Software
power supply	9V alkaline battery Typ 6LR61
environment	
storage temperature	-10°C up to +70°C
operation temperature	0°C up to +55°C
housing protection	IP 50
Dimensions	
weight	185 g
length	135 mm
width	70 mm
height	24 mm
material	ABS

11 Operation with other RF ID Equipment

As there may be electromagnetic interference between different readers, this reader shall not be operated within a distance of 3m from any other RFID reader. Otherwise a proper reading result cannot be guaranteed.

12 Safety Instruction

The manufacturer can not be held liable for damages caused by improper use or abuse, lack of reasonable care, or manipulations contrary to the recommendations given in this manual.

Do not open the reader! There are several spots inside the device, where high voltage is generated during the scanning process.

The ARE H9 Reader does not contain any parts to be repaired by the user. Any attempt to open the reader may damage the device. Therefore it may be repaired only by authorized personal. Environmental conditions, as given in section 10, have to be observed during storage and operation.

Protect the USB interface socket against dirt, moisture and dust.

For cleaning of the reader and cable use a moistened towel. Never use chemical solvents like e.g. acetone.

Do not submerge the reader in water.

13 FCC Information

Federal Communications Commissions (FCC) Statement

15.21

You are cautioned that changes or modifications not expressly approved by the part responsible for compliance could void the user's authority to operate the equipment.

15.105(b)

This equipment has been tested and found to comply with the limits for a Class B digital device, pursuant to part 15 of the FCC rules. These limits are designed to provide reasonable protection against harmful interference in a residential installation. This equipment generates, uses and can radiate radio frequency energy and, if not installed and used in accordance with the instructions, may cause harmful interference to radio communications. However, there is no guarantee that interference will not occur in a particular installation. If this equipment does cause harmful interference to radio or television reception, which can be determined by turning the equipment off and on, the user is encouraged to try to correct the interference by one or more of the following measures:

- Reorient or relocate the receiving antenna.
- Increase the separation between the equipment and receiver.
- Connect the equipment into an outlet on a circuit different from that to which the receiver is connected.
- Consult the dealer or an experienced radio/TV technician for help.

14 Notification of changes

revision	date	description of changes	Editor
001	16.02.2010	first revision	HL
002	07.04.2010	Bluetooth option added Some corrections	HL
003	21.08.2012	Addition for Serial Version	HL
004	10.09.2012	Rs232-Configuration added	HL
005	17.10.2012	index added	HL
006	9.12.2015	Reader Terminal	MM
007	19.05.2016	FCC Information	MK
008	17.06.2016	FCC Information correction	MK

15 Contacts

To improve our products, as well as its documentation is our permanent effort.

For any questions, feedback or comments please call:

Tel.: ++49 (0)731-140088-0

Fax: ++49 (0)731-140088-9000

e-mail: sales@aegid.de

http:\ www.aegid.de