

airgle®  
Precisely Pure

# Owner's Manual

Airgle® Air Cleaner (Model: AG500)

Airgle® Multigas Air Cleaner (Model: AG550)

Airgle® Clean Room Air Cleaner (Model: AG600)



This air cleaner complies  
with the federal ozone  
emissions limit.  
ARB CERTIFIED





## WARNING

### Important safety instructions

#### READ AND SAVE THESE INSTRUCTIONS











Read all instructions before using this air cleaner.

When using an electrical appliance, basic precautions should always be followed, including the following:

- Make sure the local voltage used for the cleaner meets the rated voltage specified on the data plate at the bottom of the machine. (It is a live 110-120V AC outlet for the United States and Canada, and a live 220-240V AC outlet for China.)
- Always turn off and unplug the air cleaner when not in use.
- Disconnect the power supply from your air cleaner by unplugging the power cable before replacing filters, cleaning, movement, or maintenance.
- Do not use attachments or filters not recommended by Airgle®.
- Do not use the air cleaner outdoors.
- Do not attempt to remove any part of the unit except the filters.
- Do not attempt to repair the air cleaner.
- Do not attempt to plug in the machine when your hands are wet.
- Unplug the power cord: please be sure to grasp the front end of the power cord rather than to pull the power cable.
- Do not soak the cleaner in water or splash water on it.
- Do not operate the air cleaner near an open flame.
- Please make sure no water or other liquids, or any foreign material enters the inlet or outlet.
- Do not obstruct the air inlet and air outlet of the air cleaner.
- To reduce the risk of electric shock, do not expose to water or rain.
- This product employs overload protection (fuse). A blown fuse indicates an overload or short-circuit situation. If the fuse blows, unplug the product from the outlet. Replace the fuse as per the user servicing instructions (follow product marking for proper fuse rating) and check the product. If the replacement fuse blows, a short circuit may be present and the product should be discarded or returned to an authorized service facility for examination and/or repair.
- Do not run cord under carpeting. Do not cover cord with throw rugs, runners, or similar coverings. Do not route cord under furniture or appliances. Arrange cord away from traffic area and where it will not be tripped over.
- Do not let children play with this product, in order to avoid unnecessary personal injury.
- Save these instructions for future reference.
- To reduce the risk of fire or electric shock, do not use this fan with any solid-state speed control device.



## CONTENTS

-  Warning: IMPORTANT SAFETY INSTRUCTIONS \_\_\_\_\_ 2
-  Component List \_\_\_\_\_ 3
-  The Airgle® Air Cleaning System \_\_\_\_\_ 4
-  Unpacking \_\_\_\_\_ 8
-  Choosing a Suitable Location \_\_\_\_\_ 9
-  Connecting to Power \_\_\_\_\_ 11
-  Airgle® Components \_\_\_\_\_ 12
-  How the Airgle® System Works \_\_\_\_\_ 13
-  Using the Control Panel \_\_\_\_\_ 14
-  Using the Remote Control \_\_\_\_\_ 19
-  Care and Maintenance of your Airgle® Air Cleaning System \_\_\_\_\_ 20

Component List	Qty	AG500	AG550	AG600
AG500 Carbon Filter (Inside Machine)	1	Yes	No	No
AG500 HEPAfast Filter (Inside Machine)	1	Yes	No	No
AG550 Carbon Filter (Inside Machine)	1	No	Yes	No
AG550 HEPAfast Filter (Inside Machine)	1	No	Yes	No
AG600 Carbon Filter (Inside Machine)	1	No	No	Yes
AG600 cHEPA Filter (Inside Machine)	1	No	No	Yes
Titanium Pro® UV Module (Inside Machine)	1	No	No	Yes
Casters	4	Yes	Yes	Yes
Remote Control and Battery	1	Yes	Yes	Yes
Owner's Manual (Warranty Cert. inside)	1	Yes	Yes	Yes



## The Airgle® Air Cleaning System

An efficient air cleaning system plays an important role when it comes to improving indoor air quality. However, an air cleaning system cannot do the complete job – it needs assistance. Controlling the sources of air pollution and making sure proper ventilation is utilized are critical components in improving air quality in your home or office.

To tackle any indoor air quality problem, keep in mind :

- Eliminate or reduce the source of air pollution as much as you can. Locating and controlling the source of pollution in your home right at the source is very effective.
- Proper ventilation is extremely important. Cleaning your air cannot reverse the fact that the air in your home or office is converted to carbon dioxide (CO<sub>2</sub>) every time someone exhales. Proper ventilation will ensure that clean fresh air is continually introduced into the room from outside.
- The most ideal method is to use an air cleaner, such as the latest second generation air purification technology from Airgle Corporation, the best and most effective air purification machine configuration that can be tailored to your needs.

Although many people do not experience extreme adverse reactions to airborne particles, some are particularly sensitive to indoor air pollution. Most individuals have some minor reactions to pungent chemical odors in the air, such as sneezing, watery eyes, etc., but such reactions will cease if one is removed from the presence of a chemical odor or if the chemical smell of the air is slowly dissipated. However, for a small number of people, even tiny amounts of air pollution can cause headaches, fainting, nausea and even endanger the life. This kind of reaction is called a chemical substance allergy or MCS.

We use chemical compositions in many products, both at work and at home, and chemical compounds can be found everywhere. Chemical substances are derived from the use of products made of chemical compositions, such as laundry detergent, shampoo, perfume and furniture, outdoor air pollutants, and other chemical gases from furniture, fireworks, clothing, carpets, and decoration materials that contain chloroform, benzene, formaldehyde, ethanol and volatile organic compounds (VOCs).

AG500 can effectively filter these toxic airborne pollutants, along with dust, pollen, pet dander, smoke and haze.

AG550 is most effective for those experiencing multiple or severe chemical allergies. With more activated carbon in the Gas & Odor filter, it can not only effectively remove gaseous pollutants, such as smoke, smells, and other volatile organic compounds, but also provide a potent degradation of



indoor decoration pollution, such as formaldehyde, benzene, etc. Activated carbon is considered the most effective way to eliminate the harmful substances in gaseous pollutants and air.

We have chosen to utilize the high adsorption properties of coconut shell activated carbon. Its rich pore structure and great specific surface area can remove formaldehyde, benzene, TVOC and other harmful gases, as well as odors, more quickly and more effectively than other available products. This brings more fresh and clean air to individuals with multiple and severe chemical allergies.

AG600 can remove various pollutants, including dust particles, smoke, bacteria and viruses, VOCs, formaldehyde, etc., and is mainly used in hospitals, clinics, healthcare facilities, laboratories, and research institutes. In the past, only medical institutions could configure these portable ultra-high efficiency air cleaners, but now Airgle offers this industrial-grade machine for home use to families afflicted by air pollution and allergic diseases. Those suffering from asthma, heavy pollen sensitivity and respiratory difficulties will greatly benefit from this revolutionary purification technology.

Airgle's second generation medical-grade purification machine uses a cHEPA ultra-high efficiency filter with a purification ability six to ten times greater than traditional HEPA technology. The cHEPA filter technology provides super-high purification efficiency. It can filter particulate matter of less than 0.3 microns, and the filtration efficiency can reach 99.991% - 99.996%. The airflow it provides is six times greater than other conventional air cleaners on the market, and it is faster and more effective at filtering airborne dust, mold spores, pollen, smoke, haze, animal dander and other stimulations of allergies. Its large filter is also economically beneficial, extending the service life of the machine, and the Airgle AG600 Air Cleaner uses a Titanium Pro® UV component, which is one of the core technologies of Airgle Corporation.

## Titanium Pro® Module

The AG600 comes with a Titanium Pro® UV module. This module is considered the next generation of photocatalytic oxidation technology, and is the first Titanium Pro® module in the world, successfully developed by the Airgle team after many years of research. The module is configured with all the components for air purification through the oxidation effect of photocatalysts and UV light.

The catalytic area in the module can effectively kill bacteria and viruses, as well as safely break down harmful chemical gases and odors.

The working principle of the Titanium Pro® UV module: This Titanium Pro® UV module surface is coated with a photocatalyst. It degrades air pollutants by exposing both the pollutants and the catalyst to the photons of UV light. The pollutants are rapidly converted into harmless substances when the UV light energy activates the catalyst.

Our patented Titanium Pro® includes the following features:

- A catalytic metal plate, an electronic component, a UV germicidal lamp and a UV lamp ballast, combined into a single disposable module - a handheld, unitized package, designed for easy insertion into and removal from the air cleaner
- Unique structure design to allow maximum airflow, rapidly diluting the concentration of unwanted airborne contaminants
- 6.40 times more effective catalytic area, compared to other conversional Tio2 modules
- 10-watt UVC lamp
- Plug and play technology
- Works at room temperature
- No chemical additives
- No residual ozone
- High oxidation yields for gas phase reactants and odors
- Low energy requirements
- Works in humid conditions
- Long service life

## The Airgle® AG500 Air Cleaning Systems

Airgle® (AG500) is designed with:

- 1) A Gas & Odor Filter
- 2) A HEPAfast Filter

Effectively filters airborne dust and particulate matter; removes pollen, pet dander, smoke, haze and odors.

Decomposition of formaldehyde, toluene and other decoration pollutants.

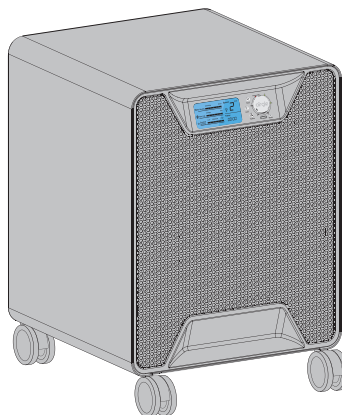

## The Airgle® AG550 Air Cleaning Systems

Airgle® (AG550) is designed with:

- 1) A Gas & Odor Filter
- 2) A HEPAfast Filter

Effectively filters airborne dust and particulate matter; removes pollen, pet dander, smoke, haze and odors.

Decomposition of formaldehyde, toluene and other decoration pollutants. Efficient removal of gaseous pollutants, such as smoke, odors and other volatile organic compounds.

Strong degradation of indoor decoration pollution, such as formaldehyde, benzene, etc.

## The Airgle® AG600 Air Cleaning Systems

Airgle® (AG600) is designed with:

- 1) A Gas & Odor Filter
- 2) A cHEPA Filter
- 3) A Titanium Pro® UV Module

The filtration efficiency is 99.991% - 99.996%.

Enhanced technology for the filtration of bacteria and viruses.

Removes dust, pollen, pet dander, smoke, haze and odors. Decomposition of formaldehyde, toluene and other decoration pollutants. Efficient removal of gaseous pollutants, such as smoke, odors and other volatile organic compounds.

Strong degradation of indoor decoration pollution, such as formaldehyde, benzene, etc.



## UNPACKING

### Unpack your Airgle® System as follows:

1. Remove the Airgle® Cleaner System from the packaging.
2. Do not throw the original box and packaging away. Keep it in case you need to transport the unit again sometime in the future.
3. Check the components received against your packing slip to make sure you have all the parts.
4. Check the unit and **all** the components for damage. If the unit or any of the components show damage from shipping, contact your local dealer.
5. For your future convenience, record the model information here. Model information can be found on the name plate located on the bottom of your unit.

Model Number:	Purchase Date:	QR Code:

Pre-installed Filters:  
 AG500/AG550:  
 HEPAFast Filter + Gas & Odor Filter

AG600:  
 cHEPA Filter + Gas & Odor Filter +  
 Titanium Pro®

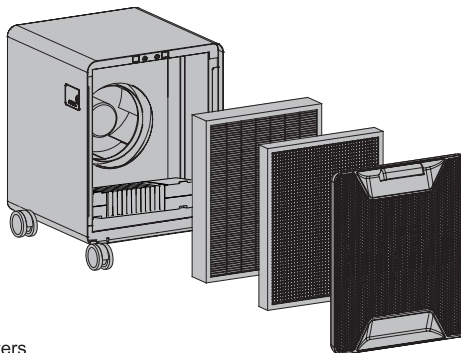

Install the supplied casters as follows:

- 1) Carefully insert caster stem into receptor tube.
- 2) Press on caster until it snaps into place. Repeat steps 1) and 2) with the remaining casters.
- 3) Ensure each caster is securely fitted before placing the machine in its upright position onto the casters.

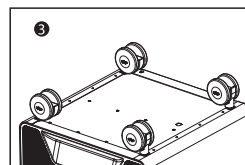
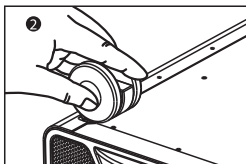
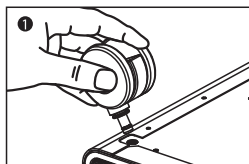



## CHOOSING A SUITABLE LOCATION

Now that you have unpacked your air cleaning system, where are you going to use it?

### Bedrooms:

Does someone in your family have allergies and/or asthma? People with allergies and asthma sometimes have a hard time sleeping, as many of their symptoms worsen during the night. Moving the air cleaning system into the bedroom at night will help them. Be sure to have one foot of space between the system and any walls, cabinets or large furniture to allow for better air circulation.

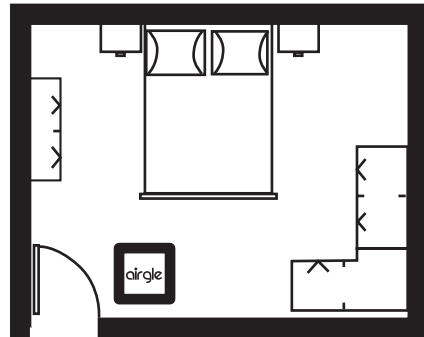

### Living/family rooms:

Placing your air cleaning system in a central location of your largest room will help purify the air in the entire room and may be beneficial to other rooms that have doorways to the main room. Be sure to have one foot of space between the system and any walls, cabinets or large furniture to allow for better air circulation.

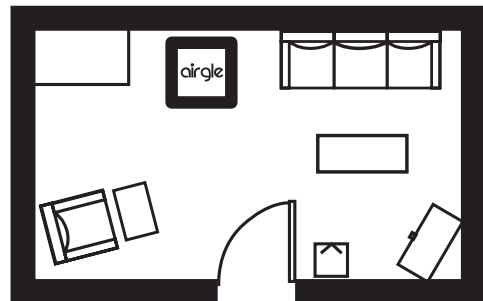

## Home office or den:

Keeping your system in your home office or den will certainly clean the air in that room – but probably only that room.

Be sure to have one foot of space between the system and any walls, cabinets or large furniture to allow for better air circulation.

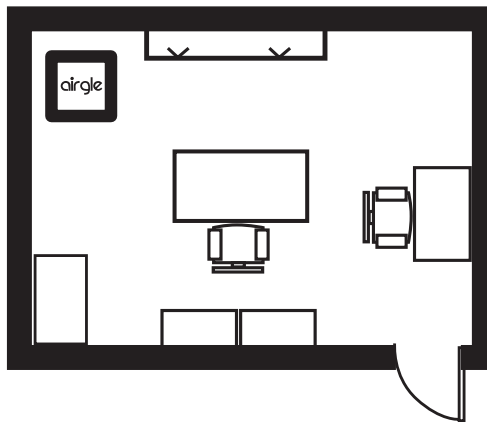

Many people will turn on their air cleaner periodically throughout the day, but we recommend you leave it on for constant air cleaning while you are using the room. After all, air pollution never takes a break, so why should your air cleaner?

We have found that many people start with one air cleaning system and move it from room to room throughout the day. You should focus your air cleaning efforts in the area where you and your family spend the most time. Some of them continue the practice of moving the air cleaner from room to room while others purchase additional units. No matter how you end up using your system or systems, please be sure to remember the following suggestions.

## For optimal performance, keep these 3 things in mind:

1. Position the air cleaning system at least one foot away from the wall. The more centrally the air cleaner is positioned, the better and faster your system will purify the air.
2. Keep the power cord away from walkways.
3. Make sure you can easily access the control panel



## CONNECTING TO POWER

After selecting the best location for your air cleaning system and clearing the space around where it will stay, connect the power cord to the unit and the other end into the socket.

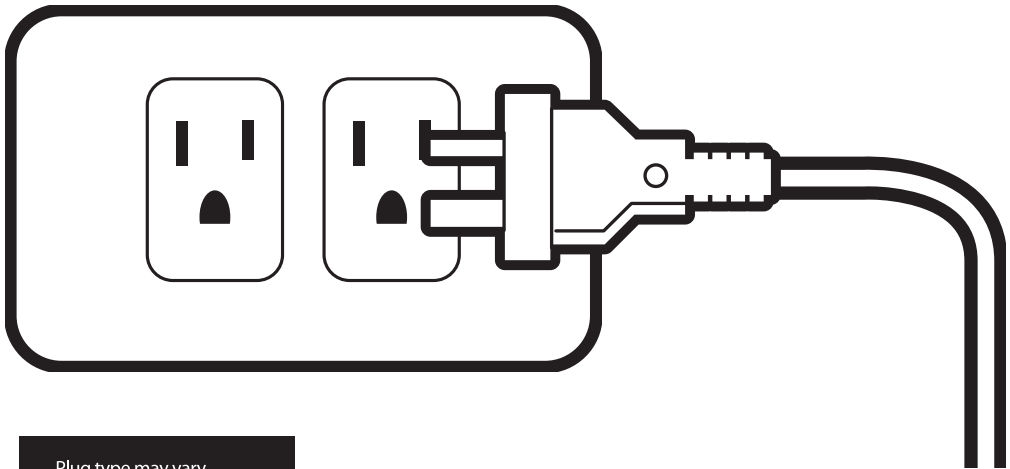

Plug type may vary

Make sure the cleaner is plugged into a live 110-120V AC outlet if you are located United States and Canada, or a 220-240V AC outlet if you are located in China.





## AIRGLE® AIR CLEANER COMPONENTS

AG500 Filter Components Showing 5 and 6 here

AG550 Filter Components Showing 5 and 6 here

AG600 Filter Components showing 4, 5 and 6 here

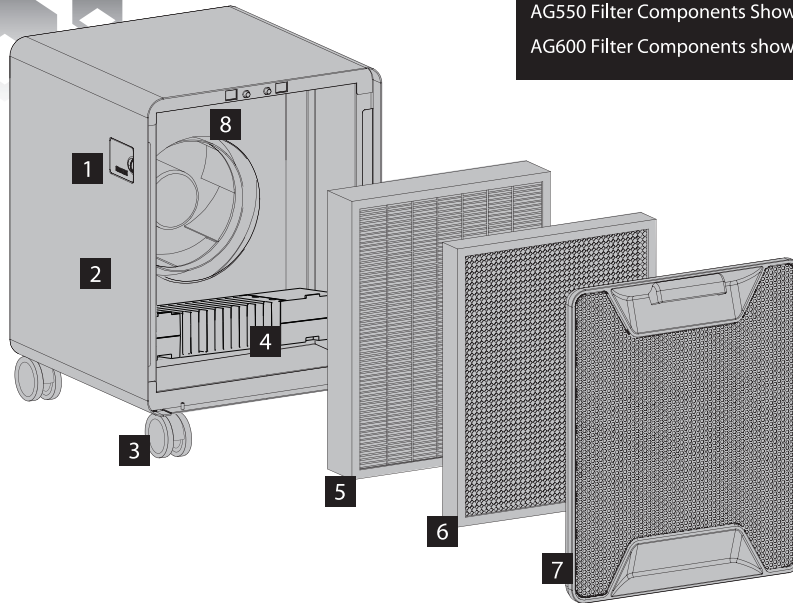

1. Sensor: Monitors the amount of particles in the room to determine airflow activity (if unit is on auto).
2. Housing: The outside "box" for the unit. You will want to make sure this is kept clean and that no areas, such as the sensor or air intake/outflow, become covered or blocked.
3. Casters: Install the casters provided with your cleaning system to make it easier to move as needed when cleaning, as well as to keep the unit off the floor for better airflow.
4. Titanium Pro®: This module is easily removed when replacement is required as indicated on the control panel. The light bulb indicator on the control panel will start blinking when the module has reached its life of 6000 hours and requires replacement (AG600 only).
5. HEPAfast Filter (cHEPA for AG600): The filter may need replaced when the light grid on the LCD control panel starts blinking. Please remove it for replacement to ensure optimal efficiency.
6. Gas & Odor Filter: This filter is removable for cleaning (by vacuum) or replacement. We recommend checking for possible cleaning every month. The filter may need replaced together with the HEPAfast filter (cHEPA for AG600).
7. Rear Door: Make sure the rear door is latched on correctly so as not to overload the air cleaning system with additional air intake that is not entering the unit in the proper manner.
8. Auto Shut Off: This safety feature will automatically turn off the unit if the Titanium Pro® UV, HEPA filter, or Gas & Odor filter is not installed in the unit, or if the rear door is removed while the unit is running.



## HOW THE AIRGLE® SYSTEM WORKS

1. Room air is drawn into the system via the rear grill.
2. The process begins when air moves through the Gas & Odor filter, which captures the large particles and VOCs that are adding to air pollution.
3. Next, the air moves through the HEPAfast filter, which captures tobacco smoke, dust mites, pollen, dander, smog, mold and other airborne pollutants of a particle size greater than 0.3 microns. (For model AG600, the filter here is an ultra-high performance cHEPA filter, which quickly and effectively filters respirable particulate matter with an efficiency reaching 99.991% - 99.996%.)
4. If your unit includes the Titanium Pro® module, the air then moves through this final filter, where additional particles are removed, and bacterial and viral organisms are destroyed.
5. Purified air is then returned to the room via the front grill.

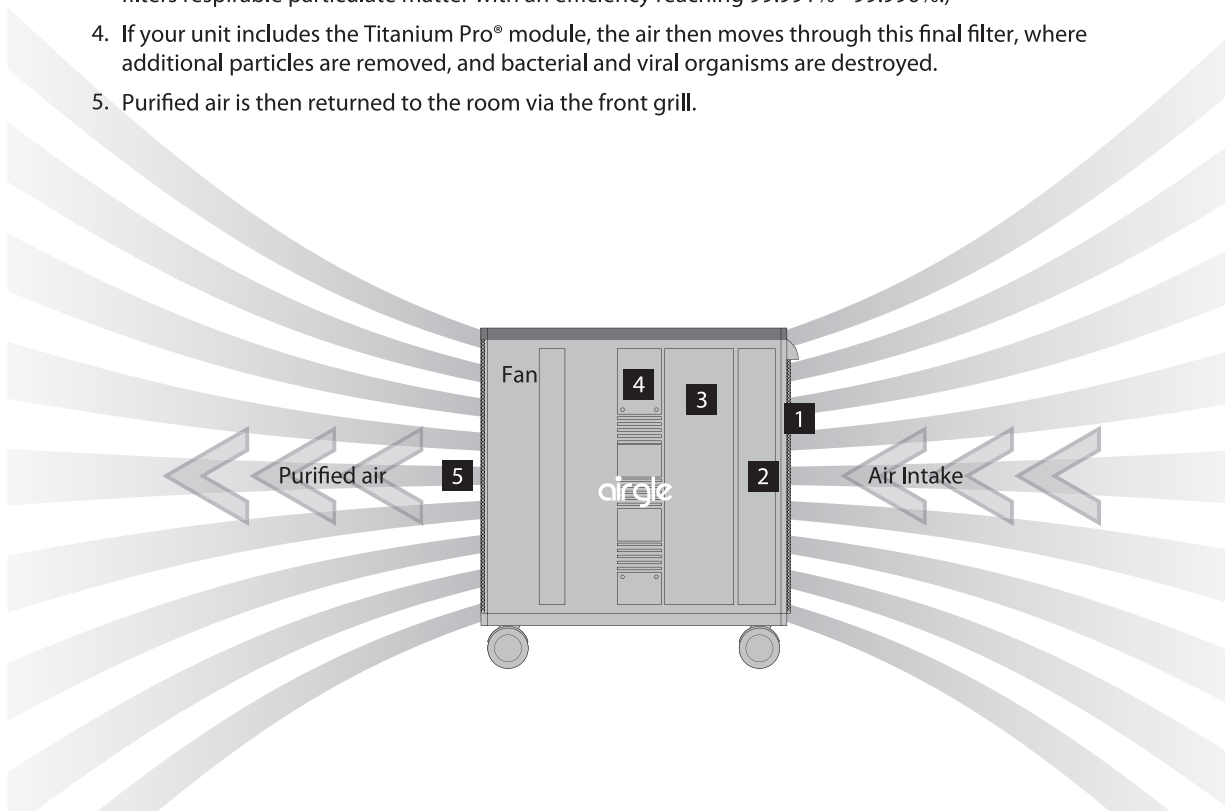



## USING THE CONTROL PANEL

The Airgle® system is equipped with a state-of-the-art control panel. This advanced control panel allows you to assess the unit's status with one quick glance.

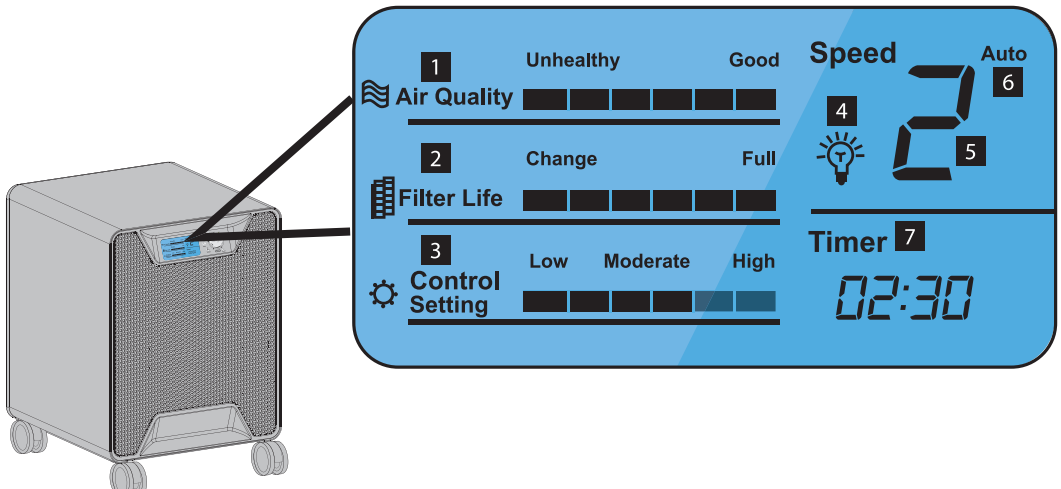
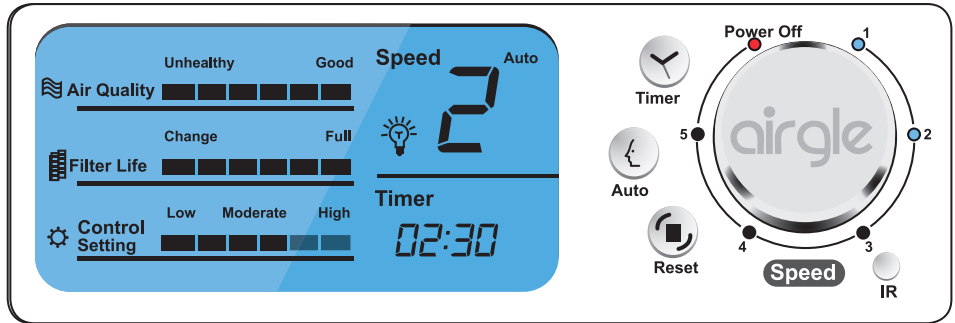

1. **Air Quality:** The Airgle® system is equipped with an advanced air quality monitoring sensor. The Air Quality Gauge displays the quality of the air in the room – the air you breathe. The six status bars indicate the quality from Unhealthy (one bar) to Good (six bars).



Unhealthy

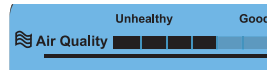

Moderate

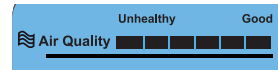

Good

2. **Filter Life:** This monitor calculates the remaining life of the system's filters. The calculation takes into account both the already elapsed operation time and fan speed. This allows for a more accurate report on filter life. The six status bars indicate if the filter should be changed (one bar) to when it is at its full life (six bars). When the filter needs attention, the first bar will be blinking.

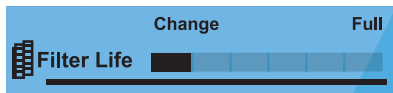

Change

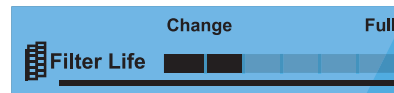

33% Remaining

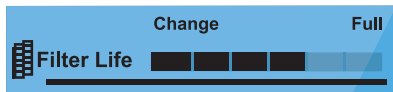

66% Remaining

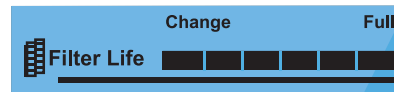

Full Life

3. **Control Setting:** This advanced setting is for users who encounter challenging air pollution environments and/or needs. The default setting is Moderate, which should be ideal for most users. For more information, please see the Control Setting section in this manual.
4. **Light Bulb:** This indicator displays if you have installed Titanium Pro . If blinking, it indicates that the filter needs to be replaced. For more information, please see the Titanium Pro section in this manual. (This function is only for model AG600.)
5. **Speed:** This indicates the speed selected by using the knob on the right-hand side of the panel.
6. **Auto:** This indicates you have elected to use the Auto Mode (selected using the button on the right side of the panel).
7. **Timer:** This indicates how much time is left until the system shuts down (activated by the Timer button on the right-hand side of the panel).

## Control Panel details: right-hand side

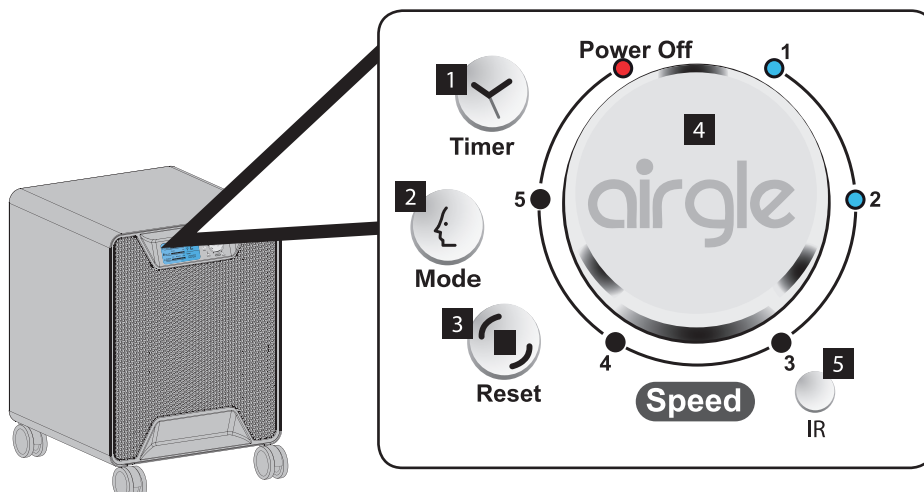

1. **Timer:** Press this button to set the timer for up to 12 hours of continuous operation. The time shows on the bottom right of the LCD display on the left-hand side of the panel. Timer button operation is as follows: The machine will run for one hour if the timer button is pressed once and the LCD displays 01:00; the machine runs for 2 hours if the timer button is pressed twice and the LCD displays 02:00, and so on to 12 hours. The machine allows you to access the control settings if the Timer button is pressed and held for five or more seconds. Please refer to the Control Settings on page 17 for details.

2. **Mode:** When you press the Mode button, the unit will automatically change to the optimum speed needed for air purification of the room and change the Air Quality light bar according to air quality. The sensor (located on the side of the unit) will tell the unit when to raise or lower fan speed depending on the amount of particles in the room.

**Sleep Mode:** Press the Mode button twice successively and the machine will start SLEEP MODE. The machine will turn off all lights (including LCD & UV lamp) and change fan speed to "1." Press the Mode button and hold down for five or more seconds to set the UV lamp On/Off setting (refer to page 17 for details). Press the Mode button again to turn the light and LCD back on.

3. **Reset:** Press this button after you have replaced any of the filters or Titanium Pro®. This will reset any blinking lights and set the filter life to full.

**Note:** This function is only activated when any of the filters requires changing. If the filter life is full, the button is disabled to prevent accidental pressing of the button.

4. **Power/Speed:** When the air cleaner is turned off, the Power Off indicator will display as red, and the fan speed indicator will be off.

To turn the system on, rotate the Power/Speed knob anticlockwise or clockwise to select a speed from 1 to 5. The light indicator for the selected speed will display as white and the speed you selected will display on the left-hand side of the panel, while the Power Off LED indicator light is off. To turn the system off, rotate the knob to the “Power Off” position anticlockwise or clockwise. The Power Off LED indicator will display as red, and the light indicator for the fan speed will turn off.

5. IR: This infrared receiver is used by your remote control to change unit settings.

## 1. Advanced Function Setting

Model AG600 includes the Titanium Pro® module.

If your unit has been installed with the Titanium Pro® module, the light bulb icon will display on your control panel. The light bulb serves to indicate whether your unit has the module installed, and also indicates when it is time to replace the module by blinking.

The Titanium Pro® module is designed to last 6000 hours. When that time is up, the light bulb icon will start blinking. After you replace the filter and press the Reset button (on the right-hand side of the panel), it will stop blinking.

If desired, the Titanium Pro® module can be turned off.

1. With the power turned off, press the Mode button and hold down for more than five seconds, the light bulb indicator on the LCD display will start blinking.
2. When the light bulb is on, press the Mode button again to turn on the Titanium Pro® module.
3. When the light bulb is off, press the Mode button to turn off the Titanium Pro® module.

## 2. Control Setting

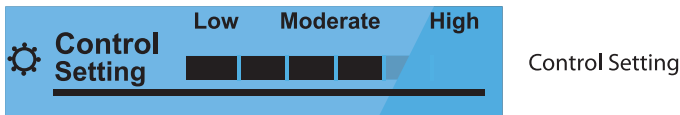

The default setting for the unit is “Moderate” and will be displayed as four bars on the control panel. This setting should meet air purification needs in most environments.

For advanced users only:

1. Make sure the unit is on Standby mode (plug in the unit and confirm knob is at the “Power Off” position).
2. Press and hold the Auto button for more than 5 seconds, you will hear a “ding” sound, the Control Setting bars will move through High, Moderate, Low, and Moderate, and then start blinking.

3. If you release the Timer button when “High” is blinking, the system is set to High Mode.

Answer the following questions to assess whether you need to change your control setting:

	Yes	No
Are you noticing severe indoor air pollution problems?	<input type="checkbox"/>	<input type="checkbox"/>
Are you or a member of your family having severe asthma and/or allergy issues?	<input type="checkbox"/>	<input type="checkbox"/>
Do you want to be able to always set your system to Auto* mode?	<input type="checkbox"/>	<input type="checkbox"/>

Auto Mode: Your system will start on high to purify the air until it senses an extremely low concentration of particles, and then will automatically change itself to the low setting.

If you answered “Yes” to any of the questions above, you may want to consider changing your setting to “High.” If you answered “No,” consider the following question.

	Yes	No
Do you have a relatively clean environment and purchased the unit for general air purification reasons?	<input type="checkbox"/>	<input type="checkbox"/>

If you answered “Yes” to this question, you may want to consider changing your setting to “Low.”

## What happens in High Mode?

When the unit is set on High, the sensor (on the side of the unit) is more sensitive to the environment. The system will auto-activate when it detects small amounts of particles in the air. Since it is more responsive to these small amounts of particles, it will activate frequently, and this will shorten the life of the filter. However, the air will be more pure in your room.

## What happens in Low Mode?

When the unit is set on Low, The sensor (on the side of the unit) is less sensitive to the environment. The system does not auto-activate until it senses a medium to high amount of particles in the air. This setting extends the filter life.





## USING THE REMOTE CONTROL

### Use the remote control to:

1. Power: Switch the system on/off.
2. Mode: Change the mode to Auto or Sleep, press the Mode button and hold down for five seconds to turn on/off the UV lamp.
3. Speed: Regulate fan speed from 1 to 5.
4. Timer: Set Timer from 1 to 12 hours.



The infrared receiver of the Airgle® system is located in the right-hand bottom corner of the control panel. In order to get the best signal transmission, the remote control should be pointed at the control panel when pressing any button on the remote.

Note: If there are barriers between the remote and the machine, the receiver may not be able to receive the signal. The remote control is pre-loaded with a battery. Please remove the insulation film on the battery before use.

### Replacing the remote control battery

1. Open the battery compartment by pressing the small lever to the side and slide the battery compartment out.
2. Remove the used battery.
3. Insert the new battery(3V battery CR2032). Be sure that the (+) and (-) are in the correct position.

### Remote Control Maintenance

1. Replace the battery if it cannot get a signal.
2. Be sure the same model battery is replaced.
3. Always put the used battery in a bag before disposal.
4. Keep the battery away from children.

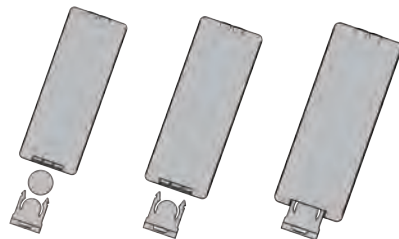



## USER SERVICING INSTRUCTIONS OF YOUR AIRGLE® AIR CLEANING SYSTEM

Your Airgle® system is equipped with a filter life monitor which will assist you in determining when a filter needs to be replaced. If indicated, replace your filters.

Always turn off the air cleaner and unplug the power cord when performing any cleaning or maintenance tasks.

### Filter Removal

Your Airgle® system provides access to all installed filters from the rear grill. Pull up the handle to remove the grill and grip the pull ribbon to remove the Gas & Odor Filter, HEPAfast Filter, or Titanium Pro® UV (If your model is AG600).

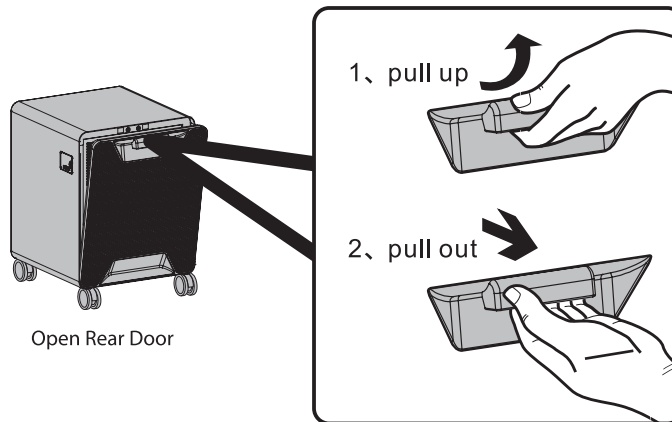

Open Rear Door

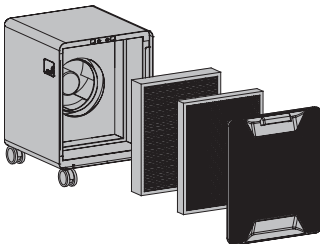

Remove Filters (AG500/550 Model)

Remove Filters and UV (AG600 Model)

## Replacing Filters

Replace the Titanium Pro® UV (Model AG600 only), Gas & Odor filter, and HEPAfast Filter (cHEPA filter for AG600) in reverse order of removal, making sure the pull ribbon is left toward the rear door when finished. Be sure the rear door is completely closed.

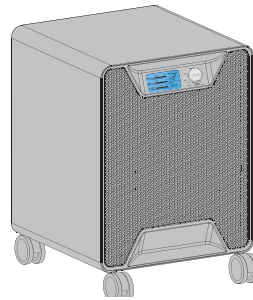

## Cleaning the Gas & Odor Filter

The Gas & Odor filter is not monitored by the Filter Check system. The Gas & Odor Filter should be checked at least every month to see if cleaning is necessary. Trapped particles in the filter build up and will block the airflow, which then shortens the life of the HEPAfast filter. This will reduce the system effectiveness in cleaning the air in your room.

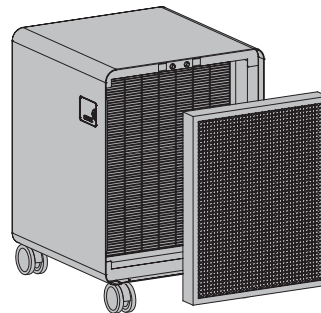

## Replacing the filter

When the first bar on the Filter Life LCD is blinking, it means the filter needs replaced. Follow the instructions on page 21 to remove the dirty filters and install new ones. Press the Reset button on the Control Panel to reset the filter. The filter life gauge should reset to six full bars.

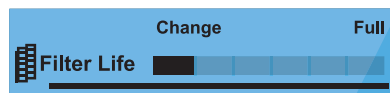
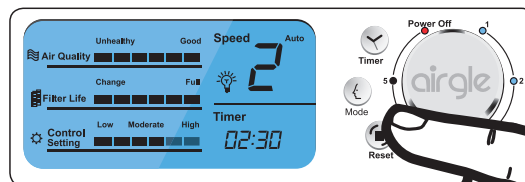

## Replacing the Titanium Pro® module

When the light bulb sign on the control panel is blinking, it means the Titanium Pro® module needs replaced. Follow the instructions above to remove the used Titanium Pro® and install a new one. Press the Reset button on the Control Panel to reset. The light bulb will stop blinking.

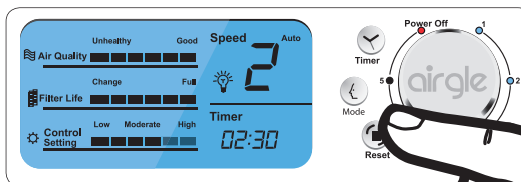

## Replacing the filter

Our unique Airgle® system design includes a rear door with a grill that acts as a filter for human hair and large particles. This aids the life of the Gas & Odor filter, the HEPAfast filter and Titanium Pro® module (if installed). Use a vacuum to clean the grill on the rear door.

Use a wet towel to sweep the housing surface.

The sensor usually needs to be cleaned once for every two months of use. Remove the sensor cover, then use lukewarm water and a small amount of detergent to clean its glass lens.

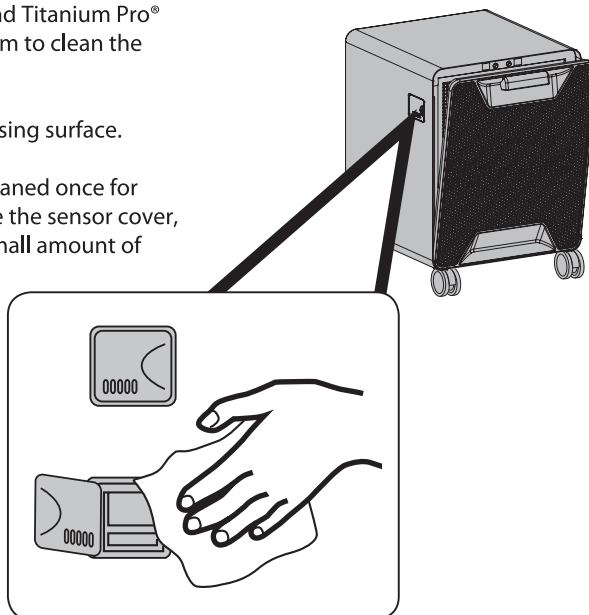

All other electronic components of the unit, such as the motor and fan, are maintenance-free.



### WARRANTY TIPS:

Airgle Corporation offers a Five Year Limited Warranty on Airgle® Series air cleaners. To activate your warranty, please scan the QR code label on the package or visit us on the web at [www.airgle.com](http://www.airgle.com)

airgle®

Precisely Pure

AIRGLE CUSTOMER CARE

☎ (866) 501-7750

@ info@airgle.com

[www.airgle.com](http://www.airgle.com)